

ULTRASONIC LOW-FREQUENCY TOMOGRAPHY

# A1040 MIRA

OPERATION MANUAL



Acoustic Control Systems – CS Group  
Saarbrücken 2018



## CONTENTS

<b>1. GENERAL INFORMATION .....</b>	<b>6</b>
1.1 THE INTENDED USE of the device.....	6
1.1.1 Intended use and application range .....	6
1.1.2 Operating conditions .....	7
1.2 TECHNICAL SPECIFICATIONS .....	7
1.3 DESCRIPTION OF THE Device .....	9
1.3.1 Design of the device .....	9
1.3.2 Data processing and data reproduction on the screen .....	15
1.3.3 Display.....	16
1.3.4 Keyboard.....	17
1.3.5 Systems and condition indication .....	19
1.3.6 Operation modes.....	19
1.3.7 Software.....	21
1.4 THE DESCRIPTION OF OPERATING MODES.....	23
1.4.1 Setting Mode.....	23
1.4.1.1 Parameter editing .....	24
1.4.1.2 Selection of gain and checking of the operating capacity of the antenna array.....	25
1.4.1.3 Automatic sample testing.....	26
1.4.1.4 Viewing parameters saved in B Scans.....	28
1.4.1.5 View and create maps.....	29



1.4.2 REVIEW mode.....	34
1.4.3 M P mode.....	36
1.4.4 Viewing the saved data.....	38
<b>2. PROPER USE.....</b>	<b>40</b>
2.1 OPERATING RESTRICTIONS.....	40
2.2 PREPARING FOR OPERATION.....	40
2.2.1 Possible use of the tomograph.....	40
2.2.1.1 Local testing.....	40
2.2.1.2 Continuous testing.....	40
2.2.2 Setting procedures.....	40
2.2.2.1 Preparation of the surface of the tested object.....	41
2.2.2.2 Creating a scanning pattern and treatment of the surface of the tested object.....	41
2.2.2.3 Switching on the device.....	41
2.2.3 Performing the testing.....	42
2.2.3.1 Performing the local testing.....	42
2.2.3.2 Performing the continuous testing.....	42
<b>3. TECHNICAL Maintenance.....</b>	<b>43</b>
3.1 REGULATORY INTENTION.....	43
3.2 REESTABLISHING THE FUNCTIONALITY OF THE DEVICE.....	43
3.2.1 Reestablishing the functions.....	43
3.2.2 Possible malfunctions.....	43
<b>4. Storage.....</b>	<b>44</b>
<b>5. Transportation.....</b>	<b>45</b>



The present operation manual (hereinafter referred to as manual) contains technical specifications, the description of the device and its functionality, and also the information necessary for the correct operation of the low-frequency ultrasonic tomograph A1040 MIR (hereinafter referred to as tomograph or device).

Prior to start using the device it is necessary to read the present manual and understand it.

We constantly improve the possibilities and increase the reliability and convenience of utilisation of the device. This can sometimes lead to some minor changes not reflected in the present version of the manual, not worsening the technical specifications of the device.

#### The device is manufactured by:

**CS-Solutions GmbH**  
**Science Park 2**  
**66123 Saarbrücken, Germany**

**Phone:** +49 (0) 681-96592270  
**Fax:** +49 (0) 681-96592280  
**E-mail:** [info@acs-international.com](mailto:info@acs-international.com)  
**Website:** [www.acs-international.com](http://www.acs-international.com)

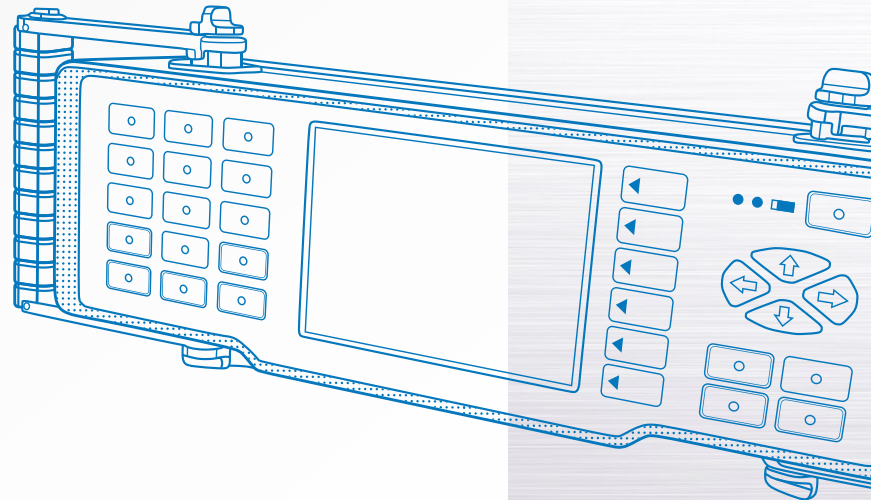



# 1

## GENERAL INFORMATION

## 1.1 THE INTENDED USE OF THE DEVICE

### 1.1.1 Intended use and application range

The device is intended for inspection of constructions made of concrete, reinforced concrete and stone with one-sided access for the purpose of evaluation of consistency of the construction, the occurrence of foreign inclusions, cavities, holes, delaminations, insufficient filling and cracks as well as for the thickness measurement of the tested object.

The device allows for quick and efficient inspection of extensive objects along with the documentation of results and the opportunity of their preliminary analysis.

The device can be used as a part of an automatic system or for manual inspection.

The main application areas of the device:

- Inspection of concrete constructions with up to 2,500 mm thickness for the purpose of evaluation of consistency of the construction;
- Inspection of reinforced concrete constructions with up to 800 mm thickness for the purpose of evaluation of consistency of the construction;
- Search for foreign inclusions, cavities, holes, delaminations, insufficient filling and cracks in the concrete objects, reinforced concrete objects and natural stone;
- Inspection of constructions made of marble and granite up to 2,000 mm thickness;
- Search for plastic and metal pipes with more than 10 mm diameter in reinforced concrete;
- Inspection of the internal structure of carbon rods with more than 900 mm diameter;
- Evaluation of the channel condition in reinforced concrete bridges;
- Inspection of understructures, columns, overhead covers in cast-in-place constructions to detect holes and insufficient filling;
- Search for holes and cavities in liner plates of underground and railway tunnels.
- Inspection of refractory blocks in glass blowing furnaces.
- Estimation of the thickness of the concrete cover and depth of upper reinforcement layers.
- Thickness measurement of an object with one-sided access.
- Detailed recording of the obtained results.

## 1.1.2 Operating conditions

The device is intended for operation under the following environmental conditions:  
Temperature from  $-10^{\circ}$  to  $+50^{\circ}$  C.

## 1.2 TECHNICAL SPECIFICATIONS

The main technical specifications of the device are listed in the Table 1

Table 1

Parameter	Value
Scanning device	internal matrix antenna array
Number of transducers in the antenna array	48
Type of the transducers used in the antenna array	Low-frequency broadband transversal with dry point contact and ceramic wearproof tips
Operating frequency	from 25 to 85 kHz
Ultrasonic velocity range	from 1,000 to 4,000 m/s
Maximum view depth in concrete	2,500 mm
Maximum view depth in reinforcement concrete	800 mm
Limits of permissible absolute measurement accuracy of the thickness, where X – thickness being measured	$\pm(0.05 \cdot X + 10)$ mm

# 1

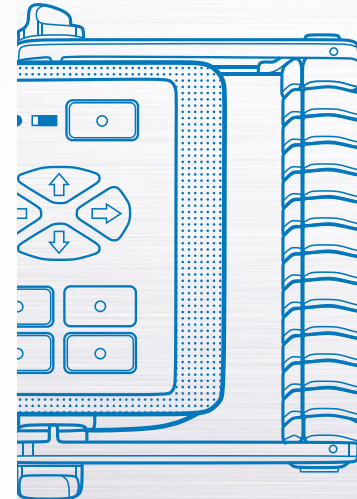



# 1

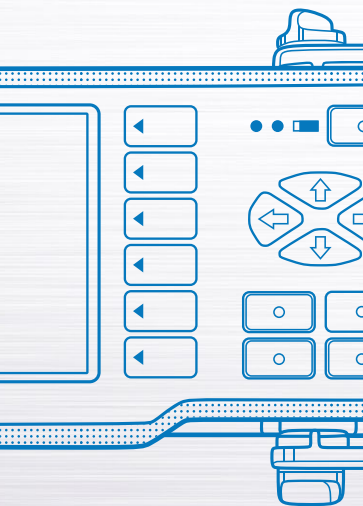

▼ Table 1

Depth measurement range of the flaw location (an area at least 20 mm Ø and at least 200 mm long)	from 50 to 400 mm
Limits of permissible absolute measurement accuracy of the depth of the flaw location, where H – is measured depth	$\pm(0.05\cdot H+10)$ mm
Power supply	Built-in accumulator
Battery rated voltage	11.2 V
Period of continuous operation of the instrument powered from the battery, min.	5 hours
Maximum overall dimensions:	
without handles	370'150'145 mm
with handles positioned horizontally	470'150'170 mm
with handles positioned vertically	370'210'170 mm
Maximum weight of the electronic module with the handles and built-in battery	4.5 kg
Average service life, min.	5 years
Operating conditions:	
air temperature range	from -10 to + 50 °C
relative air humidity at +35°C, max.	95%

## 1.3 DESCRIPTION OF THE DEVICE

### 1.3.1 Design of the device

A1040 MIRA tomograph is designed like a single housing unit with removable handles (Figure 1). The device has an integral computer and antenna array.

The button "Start" (trigger) is intergrated in the handle. It is used to start the signal transmission.

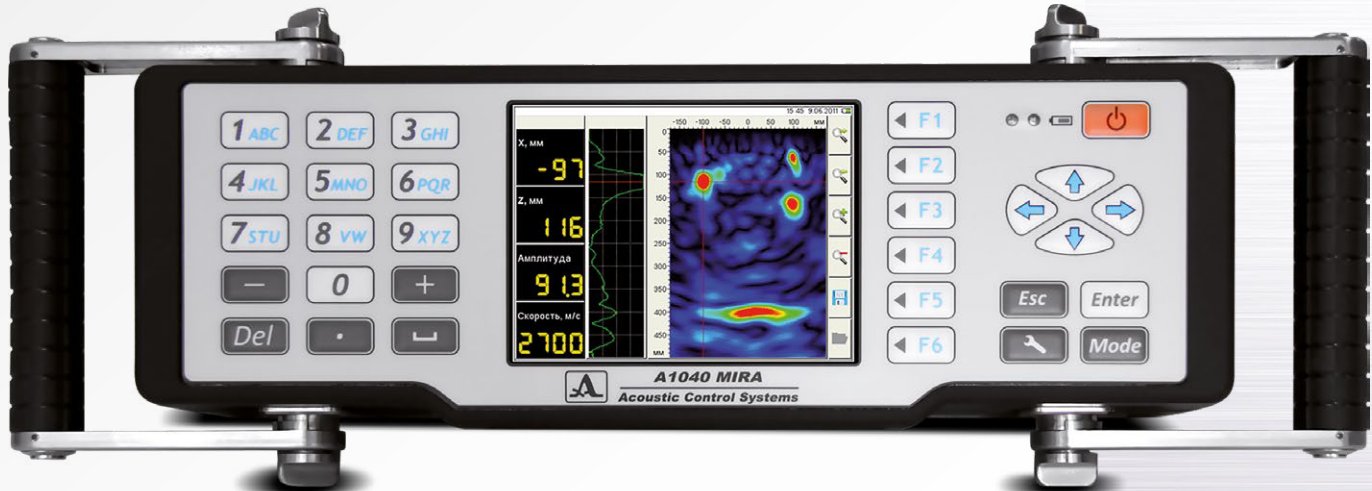
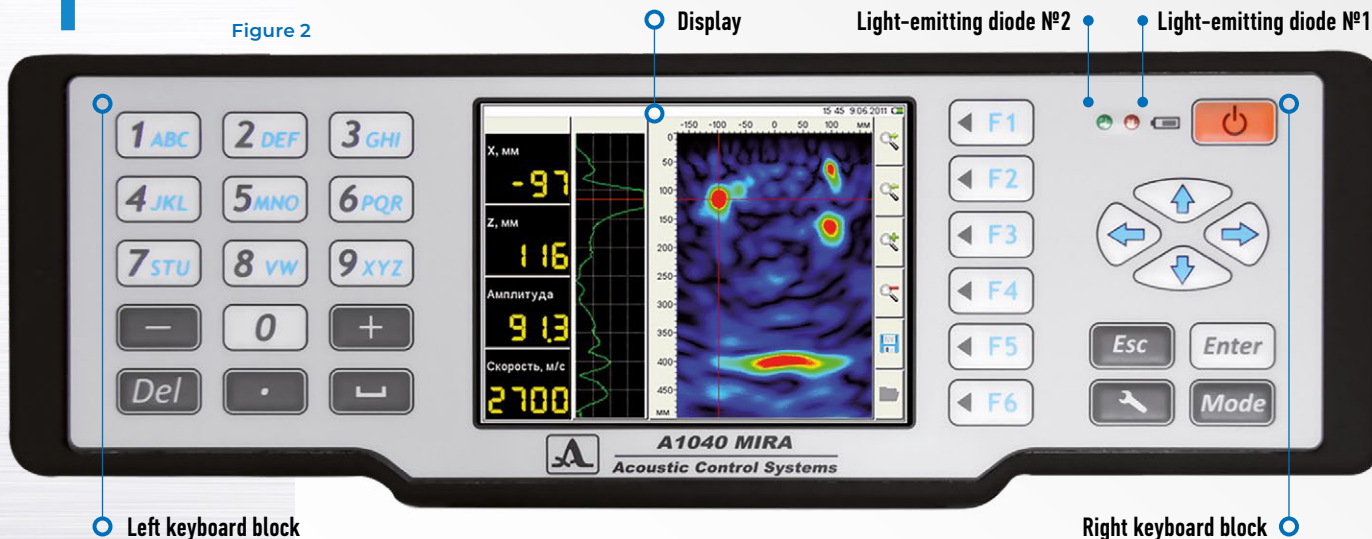

Figure 1

The front panel of the device includes: a big display, a keyboard and two LED indicators (Figure 2).

1

Figure 2



When the device is switched on the light-emitting diode No.1 lights up green.  
 During the battery charging the light-emitting diode No.2 lights up orange. When the battery is charged, the LED turns green.  
 At the end of the unit an external power connector and a USB connector are located.  
 The tomograph is a fully-autonomous measurement unit for collection and tomographic processing of the data obtained.

The measurement unit contains of a matrix antenna array with 48 (12 blocks, each containing 4 elements) low-frequency broad banded transducers of shear waves with dry-point-contact and ceramic wear resistant tips. Hence, they can work with rough surfaces for the long time. Each transducer is equipped with an independent spring suspension, thus allowing inspection on uneven surfaces. The rated array frequency is 50 kHz. (Figure 3).

Figure 3



1



1

As the antenna array consists of dry point contact transducers, the inspection is conducted without any liquid.

The interface ensures the use of laser beams which are projected on the surface of the testing object. Thus, the operator can correctly maintain a shift step of the antenna array while performing comprehensive technical diagnostics of the testing object.

The handheld light-weight enclosure and movable handles provide operational comfort on the horizontal, vertical and roof surfaces. The reference scale located on the lower part of the tomograph is designed for convenient localization of the defects relative to the antenna device. (Figure 4).

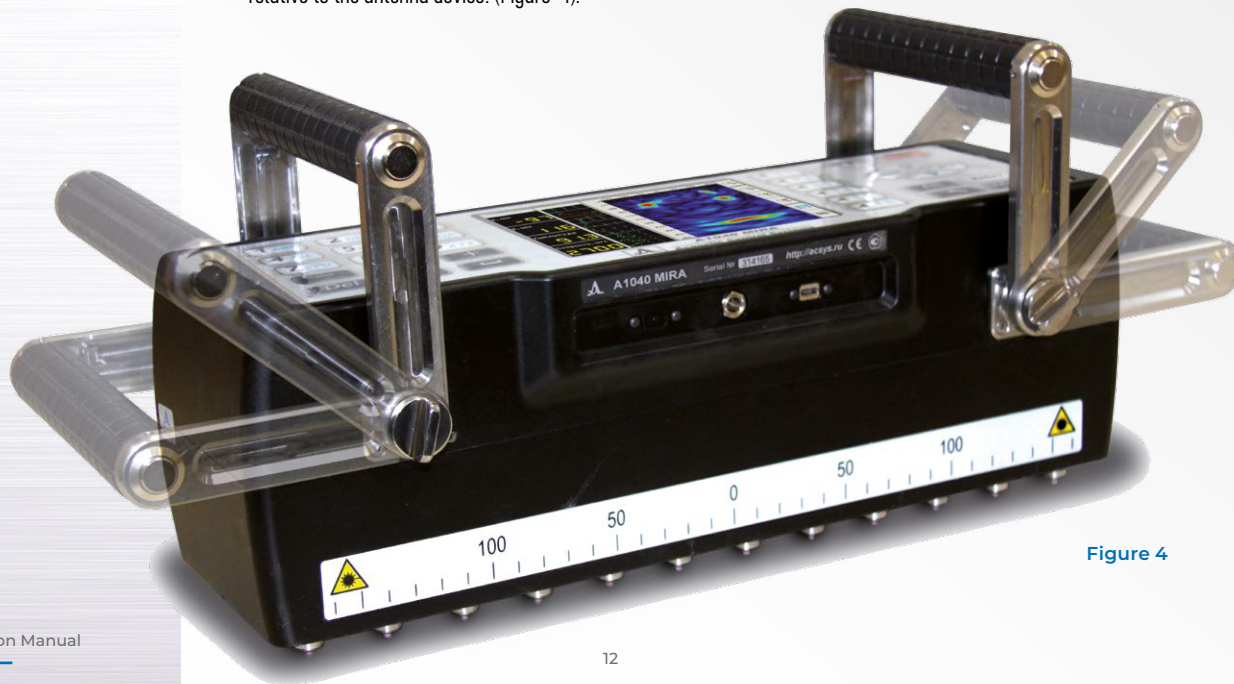

Figure 4



The internal rechargeable battery provides for 5 hours of the tomograph operation. The increased charge-discharge cycle enhances reliability of the tomograph for long-term applications. Besides, the tomograph can be powered directly from the AC mains. (Figure 5).

Figure 5





1

The tomograph allows to transfer data to the external PC for advanced processing by means of a dedicated software. (Figure 6). The inspection is carried out as a step-by-step sounding of the testing object with data combining and volume reconstruction over the whole scanned surface of the testing object. (Figure 7).

Figure 6

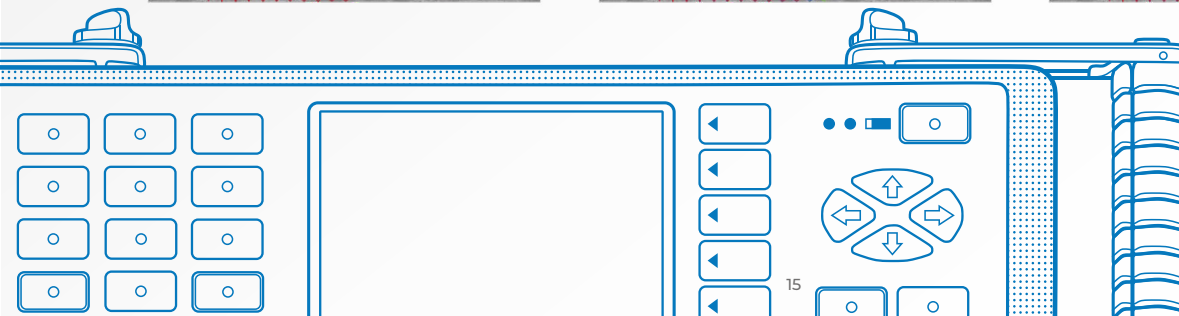
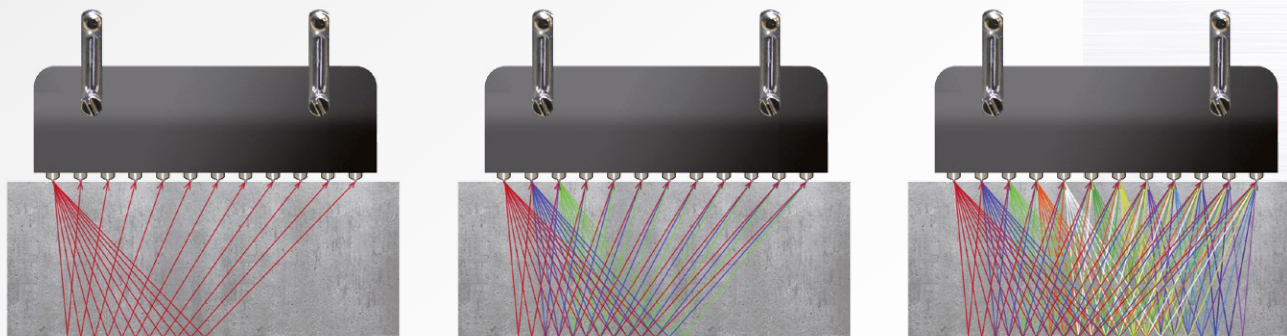

Figure 7

### 1.3.2 Data processing and data reproduction on the screen

The focusing technique of the synthetic aperture with combinational sounding (SAFT-C) is used in the device. The focusing is made in every point of the half-space. The data array is formed by the information received from all antenna measuring pairs of the device. As a result, a visual image of the cross-section of the testing object is generated, where the reflecting power of every point of the visualized volume is coded in different colors (depending on the chosen palette). (Figure 8)

Figure 8



# 1

## 1.3.3 Display

In all operating modes there is an information about time and date and the battery condition in the top information line of the display. At the right the vertical line with icons is located. Their functions vary depending on a device operating mode.

Other information represented on the screen depends on the selected mode.

The screen in the REVIEW mode with A-scan is shown in Figure 9.

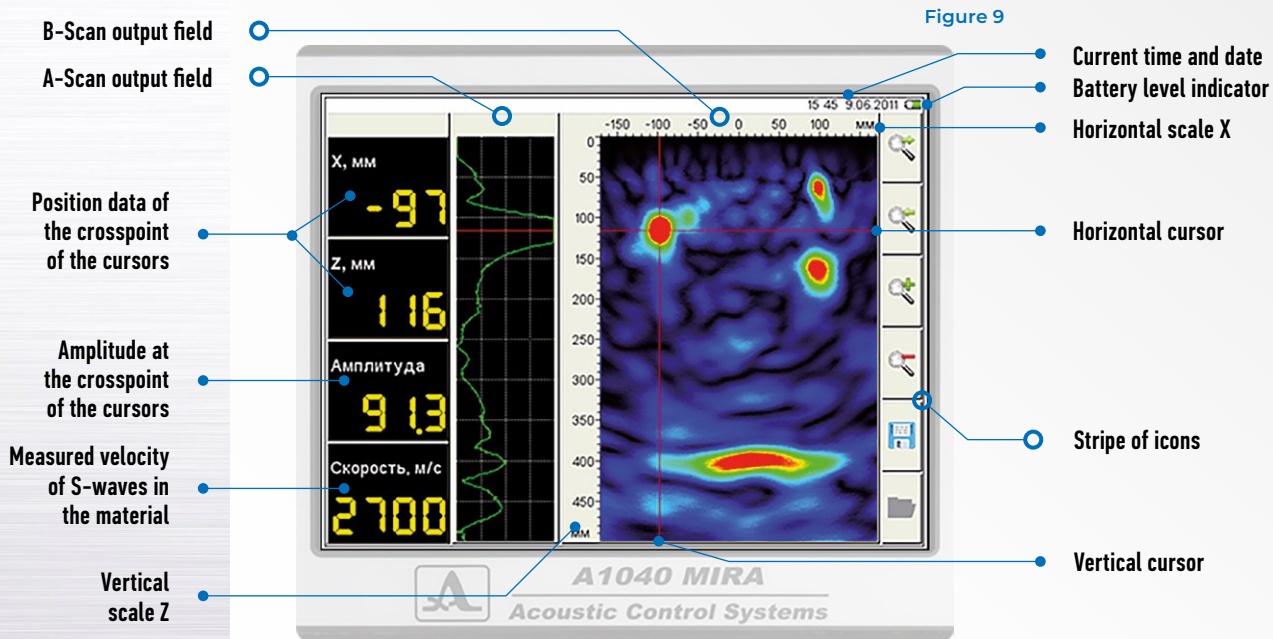

### 1.3.4 Keyboard

The operating keyboard consists of two parts located at the left and at the right of the display. The left part of the keyboard (Figure 10) includes the expanded alphanumeric block. The basic key functions are shown in the Table 2.

Table 2







Key	Purpose
 ... 	Alphanumeric keys used for editing configuration names, MAP or B Scan
 	Change a parameter value in SETTINGS mode, moving in a line of editing
	Point in the name editor
	Remove symbol in front of the cursor when editing a configuration name or B-scan
	Space in the name editor

Figure 10



The right part of the keyboard (Figure 11) includes a key of ON / OFF of the device, six function keys, navigation keys and switching between operating modes keys. The basic key functions are shown in the Table 3.

# 1

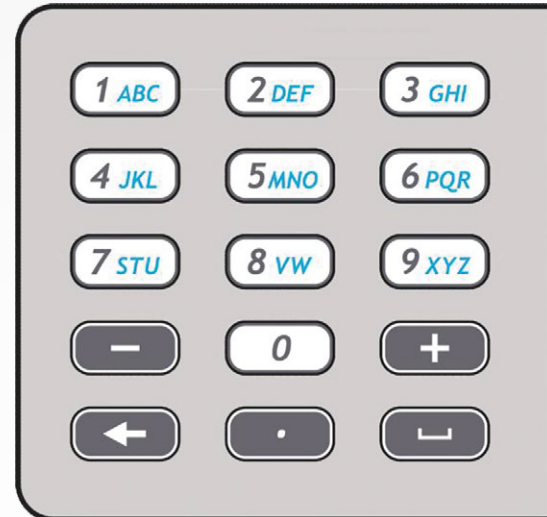
Figure 11

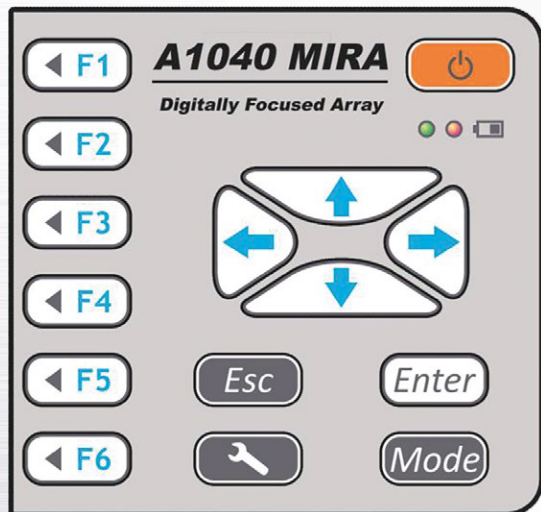



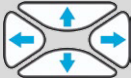





Table 3

Key	Purpose
	ON / OFF
 ... 	Function keys for various actions, depending on the selected operating mode of the device. The description of the current function in form of an icon is shown on the display to the left of each key.
	Navigating keys, used for cursor navigation, navigation in a MAP, navigation in the name editor
	Cancellation of operation / exit the editing without saving
	Enter/exit the SETTINGS mode
	Select confirmation
	Switching between modes REVIEW / MAP



### 1.3.5 Systems and condition indication

For your convenience the trigger button is located on the handle. By pressing this button, the signal transmission and reception starts.

By pressing the trigger button, the field for data collection appears.

**NOTE: TO OBTAIN CORRECT RESULTS OF INSPECTION DO NOT MOVE THE DEVICE AND WEAKEN THE CLAMPING DURING THE DATA COLLECTION PROCESS!**

After the completion of data collection, the indicating field changes its color from red to green – the calculation of data is going.

### 1.3.6 Operation modes

The tomograph has two main operation modes, as well as an adjustment function of the inspection parameters for each testing object suitable for further on-line selection. The device allows to select different types of data representation on the screen during operation depending on the used operation mode.

#### REVIEW MODE

This mode is used for quick viewing of the internal structure of the testing object in random places. The B-Scan is displayed on the screen to a depth up to 2.5 meters. (Figure 12).

Additionally the following procedures are performed in this mode:

- automatic determination of the propagation velocity of ultrasonic waves
- measurement of the coordinates and image levels in the tomogram
- thickness measurement of the testing object
- save and view B-Scans
- view A-Scans.

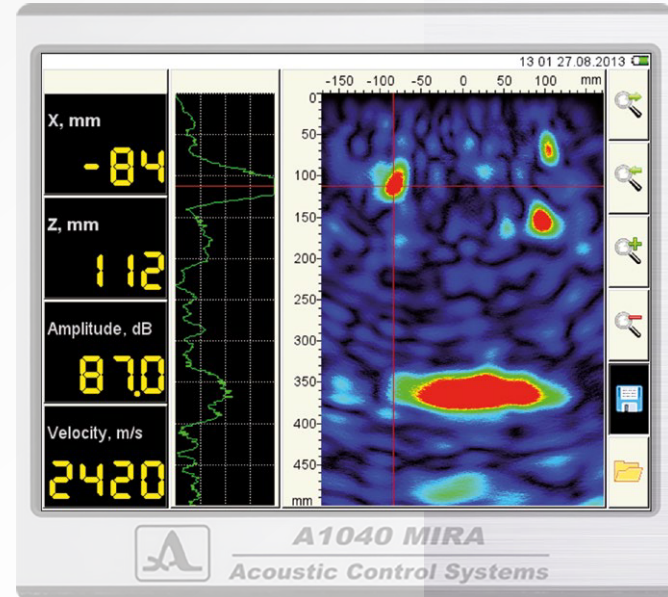

Figure 12

# 1

## MAP MODE

This mode is used for the generation of the data arrays in form of B-Scans (perpendicular to the surface) when scanning with the antenna array along the marked lines with a constant step. Any B-Scan from the collected three-dimensional data set can be shown on the screen.

The inspection is performed using step-by-step scanning of the inspected object with data accumulation and volume reconstruction of all scanned area of the inspected object on the external computer. (Figure 13).

Figure 13

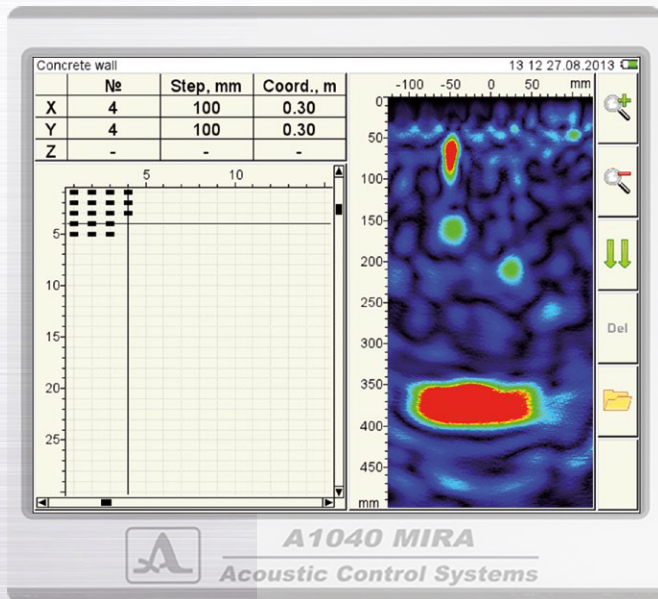
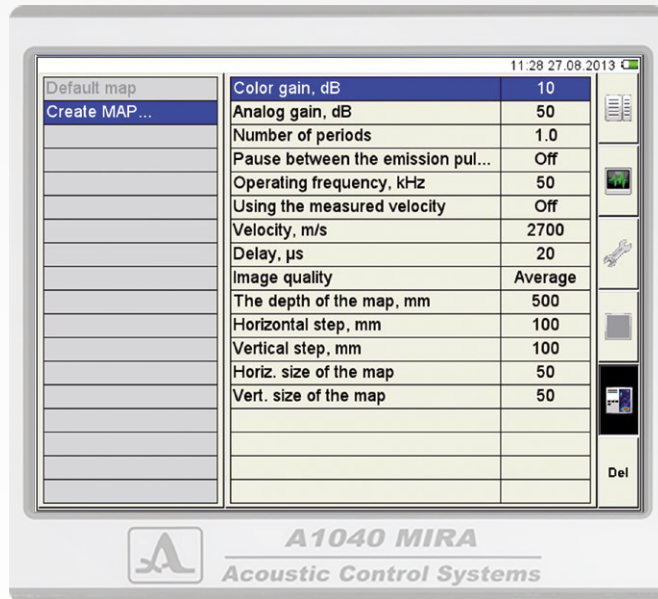

Figure 14





## SETTING MODE

This mode is used to select and set the parameters and operating pattern. There is a possibility to create and save a set of operating patterns under unique names for different testing objects. The required pattern is then selected from the saved list directly on the real object. (Figure 14).

### 1.3.7 Software

The collected data set can be transferred to the external PC for advanced processing via special software. The software allows to read the data from the instrument and represent them as tomograms as well as 3D images, thus the operator can easily understand the configuration of the internal structure of the particular testing object. It is possible to determine the occurrence coordinates of each reflector in the testing object. (Figure 15).

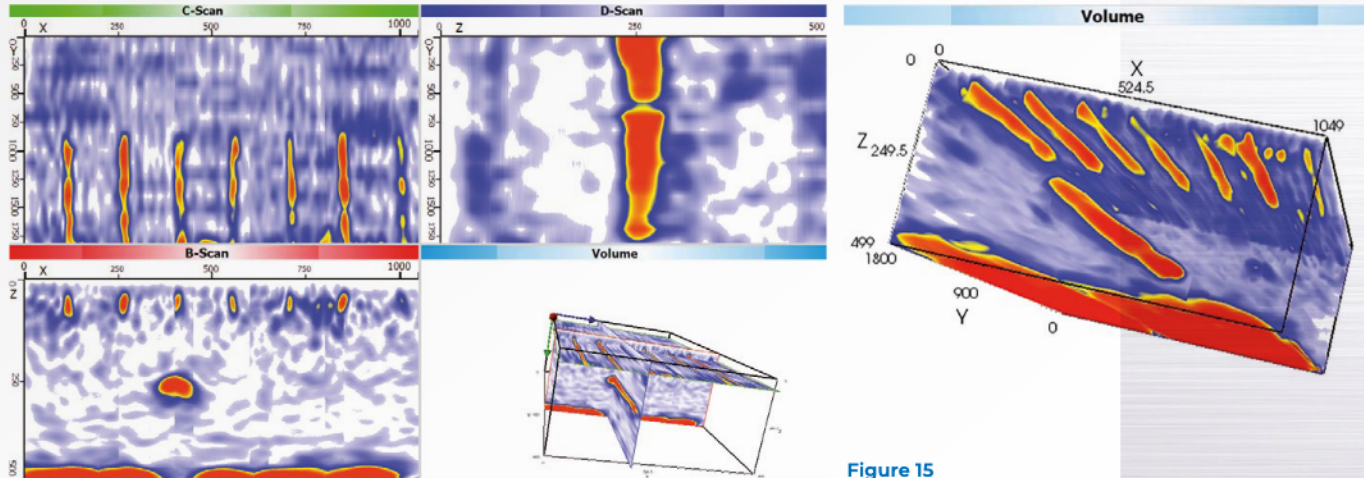
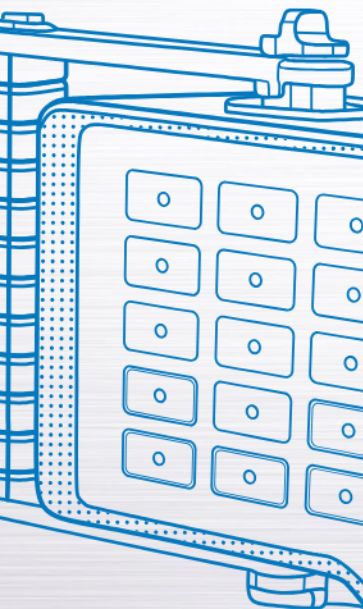

Figure 15

1



Axis Y is located along the surface of the testing object, all along the tomograph. The correct direction is from left to right. The zero is in the middle of the antenna array.

Axis Z is located in the depth of the testing object, it is perpendicular its surface. The correct direction is into the depth of the testing object (where the transducers look). The zero is on a surface of the testing object.

B-Scan any section of testing object, perpendicular to axis X.

C Scan any section of testing object, perpendicular to axis Z.

D Scan any section of testing object, perpendicular to axis Y.

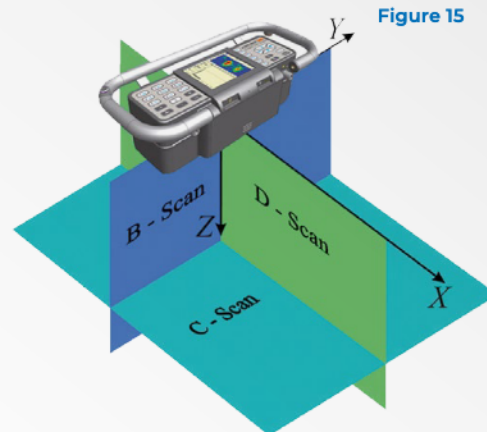

Figure 15

**NOTE: THE SPECIFIC SOFTWARE IS NOT INCLUDED IN THE DELIVERY KIT OF THE DEVICE**

The external software for A1040 MIRA with the possibility of forming 3D models of the object can be ordered directly in ACS-Solutions GmbH, Germany.

The contact information:

Science Park 2, 66123 Saarbrücken, Germany,

Phone.: +49 681 9659-2272, Fax: +49 681 9659-2280

info@i-deal-technologies.com

## 1.4 THE DESCRIPTION OF OPERATING MODES

### 1.4.1 Setting Mode

The mode SETTING is used to set and install the device parameters. When starting to work on a new testing object it is always necessary to begin in this mode. To enter / exit the SETTING mode is necessary to press the key . The main screen in the SETTING mode is shown on the Figure 16. In the left column the list of parameters is given, and in the right column their values are given.

Functions of the icons in the SETTING mode during the parameter editing are given in the Table 4.

Table 4











Key	Icon	Description
		Adjustment of parameters
		Select gain and check the working capacity of the antenna array
		System options of the device
		Absence of the B Scans saved / Review of B-Scans parameters saved in memory of the device
		View the existing and create new MAPS



Figure 16



1

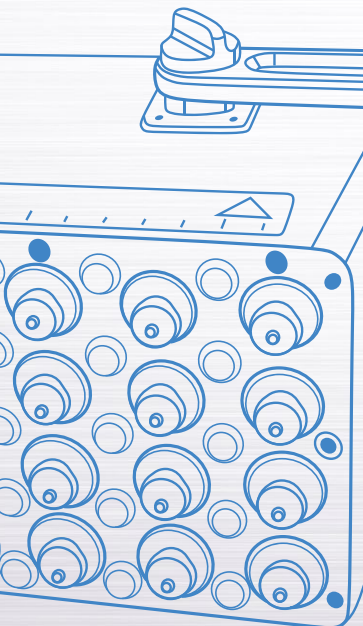

### 1.4.1.1 Parameter editing

Access to all parameters in the SETTING mode for editing.  
The key functions for parameter editing are shown in the Table 5.

Table 5

Key	Description
	Moving up and down the lines to select a parameter
	Change parameter value
	Exit the SETTING mode

The parameters and their permissible values are given in the Table 6.

Table 6

Parameter	Value	Description
Color gain, dB	from 0 to 48 with step 1	Change the scale of brightness for a synthesized image
Analog gain, dB	from 0 to 60 with step 1	Select of the strengthening factor in a path of the device for maintenance of the maximum dynamic range in the absence of restriction of signals
TGV, dB/m	Off/ from 0.5 to 10.0 with step 0.5	OFF / installation of the time corrected gain value (DAC)
Number of periods	from 0.5 to 5.0 with step 0.5	Setting depending on material properties
Pause between impulses, $\mu$ s	Off / from 1 to 50 with step 1	Influences the echo to eliminate the after sound
Operating frequency, kHz	from 25 to 85 with step 5	Setting depending on material properties

Table 6



Parameter	Value	Description
Using the measured velocity	On / Off	Select the speed for SAFT formation On – the measured velocity of S-waves Off – setting speed in the SETTING mode
Velocity, m/s	from 1500 to 4 000 with step 1	Manual velocity setting
A – Scan	Off / Filled / Empty	Off/On of the A-scan indication on the screen / Switching between types of display A-scan

#### 1.4.1.2 Selection of gain and checking of the operating capacity of the antenna array

The following image is indicated on the display when the analogue gain is selected and the operating capacity of the antenna array is checked, see Figure 17, page 26. The signal from the transmitter and the receiver is displayed on the screen.

Key function during the selection of the analogue gain and the operating capacity check of the antenna array are given in the Table 7.

Table 7

Key	Description
	Moving up and down the lines to select a parameter
	Change parameter value
	Exit the SETTING mode

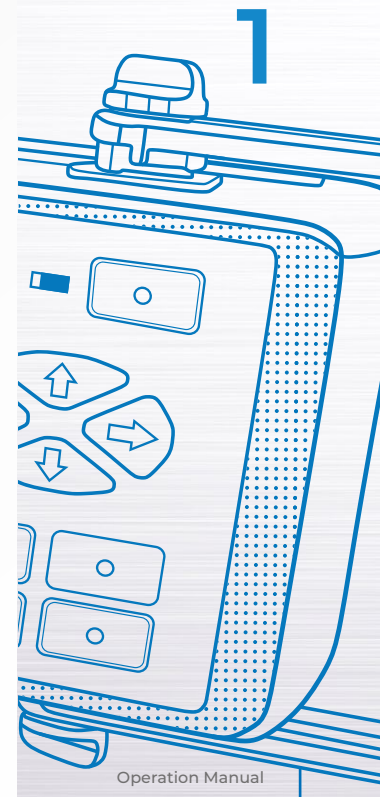



1

### 1.4.1.3 Automatic sample testing

In the delivery kit a test sample is included. The sample is a plastic plate with holes. It is used to perform the functionality test of each block of the antenna array.

For automatic testing and checking the functions of the tomograph system please perform the following operations:

- Put the sample with its holes up;
- Select "Automatic testing of sample" in the SETTINGS;

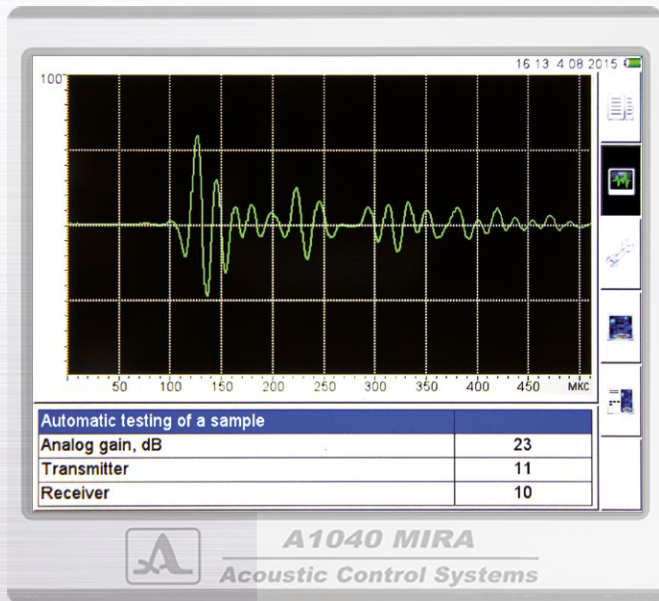

Figure 17

Figure 18



- Put the tomograph on the plate and press it down so that each transducer is in a hole;
- Press the button "data collection" is located on the handles of the tomograph;
- If the tomograph is ready, the following information will be displayed on the screen (Figure18).
- If the tomograph is not ready, the following information will be displayed on the screen (Figure19).

In this case it is necessary to contact with service center of the manufacturer by e-mail at [info@acs-international.com](mailto:info@acs-international.com) or by phone: **+49 681-9659-2270**.

System options. When setting the device options, the following information is displayed on the screen, see Figure 20.

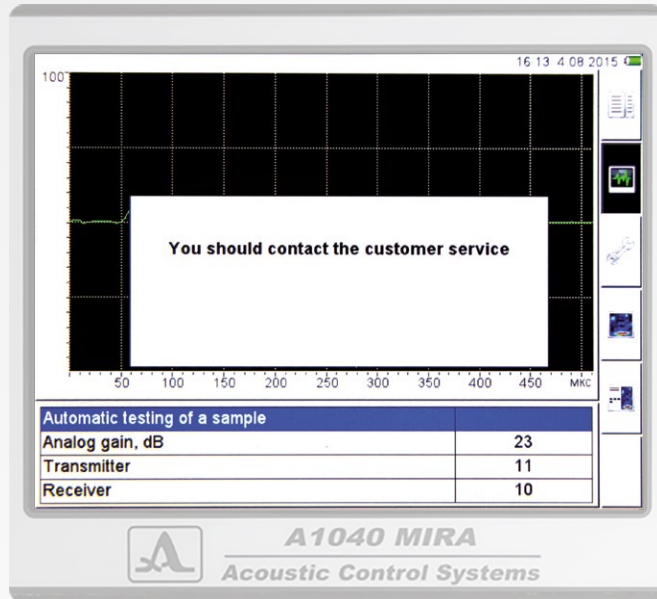

Figure 19

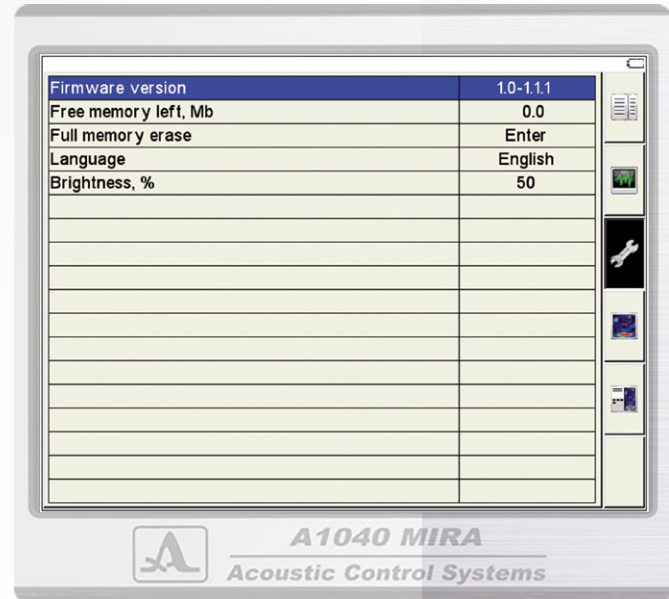
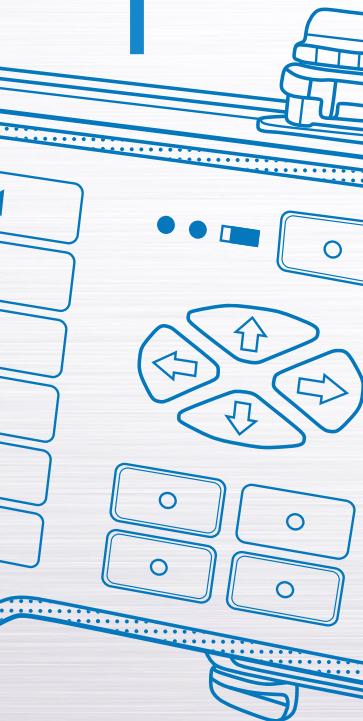

Figure 20



# 1



The parameters and their permissible values are given in the Table 8.

Table 8

Parameter	Value	Description
Firmware version	-	The current firmware version
Free memory left, Mb	-	Free memory left
Full memory erase	Enter	Start of memory cleaning procedure by pressing the key <b>WARNING: THE MEMORY WILL BE CLEANED COMPLETELY. ALL OPTIONS AND DATA WILL BE DELETED!</b>
Language	Russian, English, German, Japanese, Chinese, Korean, Spanish, French, Polish, Turkish	Select the language of the device interface
Brightness, %	from 1 to 100 with step 1	Setting the brightness on the device screen

### 1.4.1.4 Viewing parameters saved in B Scans

When entering the mode, in the first line the name of the previously saved B-Scan is marked. All the parameters of the previously saved B-Scan are shown on the right (Figure21).

For viewing the parameters of the saved B-Scan, it is necessary to select its name using the keys .

For viewing the saved B-Scans on the screen, please select its name in the list and press the key .

For removing any saved B-Scan, please press the key .



### 1.4.1.5 View and create maps

When entering the mode, in the first line the default map is marked, the parameters of the map are shown on the right (Figure 22).

For Viewing the parameters of the saved map, please select its name using the keys  .

For viewing the saved B-Scans card on the screen, please select its name in the list and to press the key .

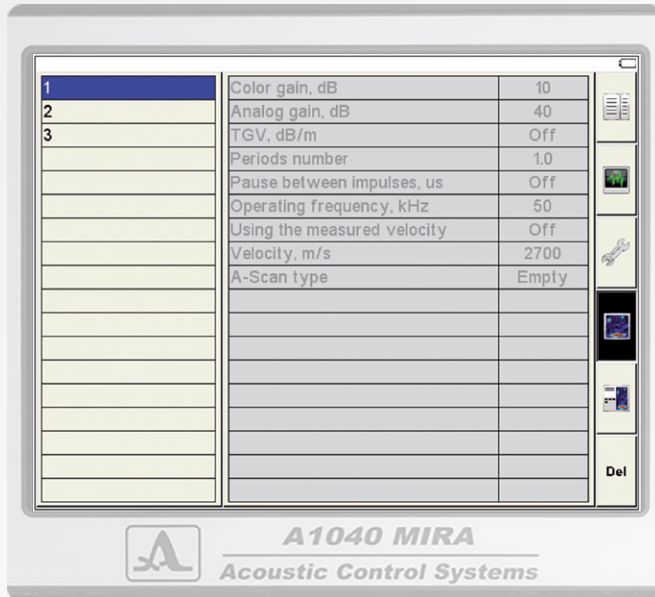

Figure 21

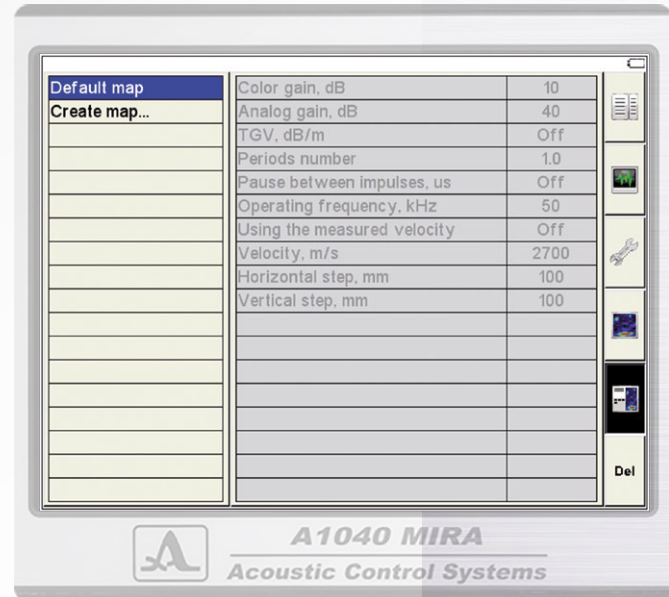

Figure 22

1

For removing saved B-scan maps, please press the key . It is impossible to clear map list completely, one map in the list cannot be removed.

For creating a new map, please select "Create a map ..." using the keys (Figure 23), in the right column the parameters described in the section 1.4.1.1 are displayed, i.e. actual operation.

To change the values, please press the key . The parameter values become active and can be edited (Figure 24).

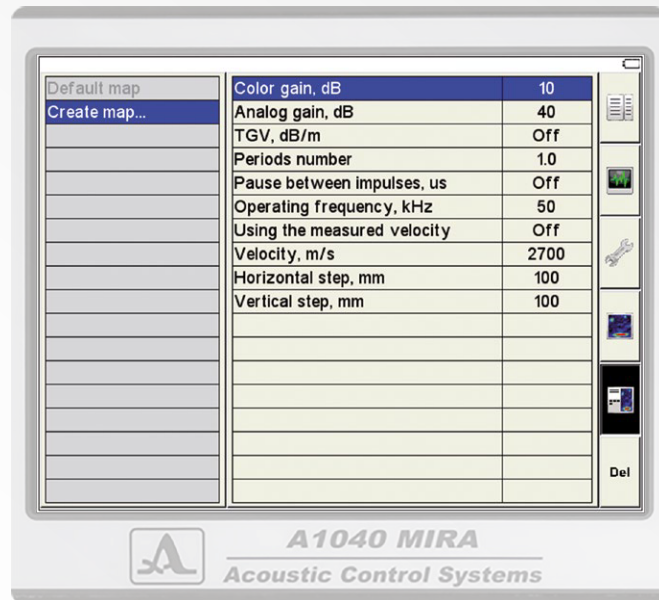
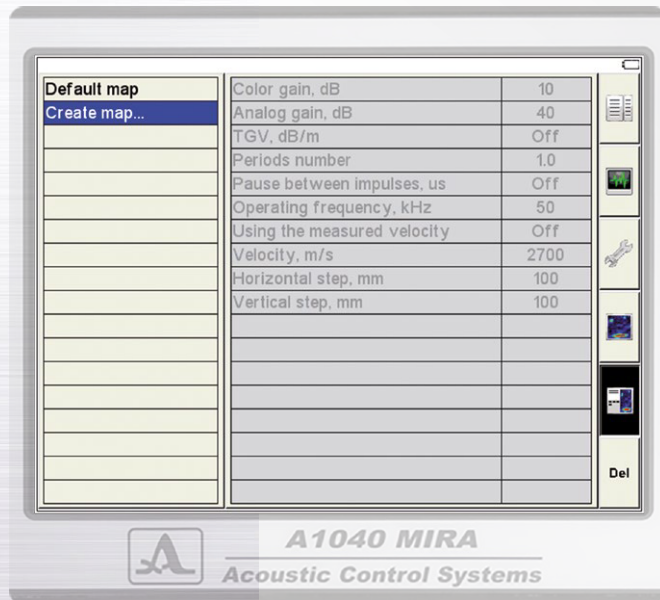



Figure 23

Figure 24

After entering changes it is necessary to leave editing by pressing a key  (Figure 25).

To save the map, please select its name, for this purpose press the key . The window for changing the map name opens (Figure 26).

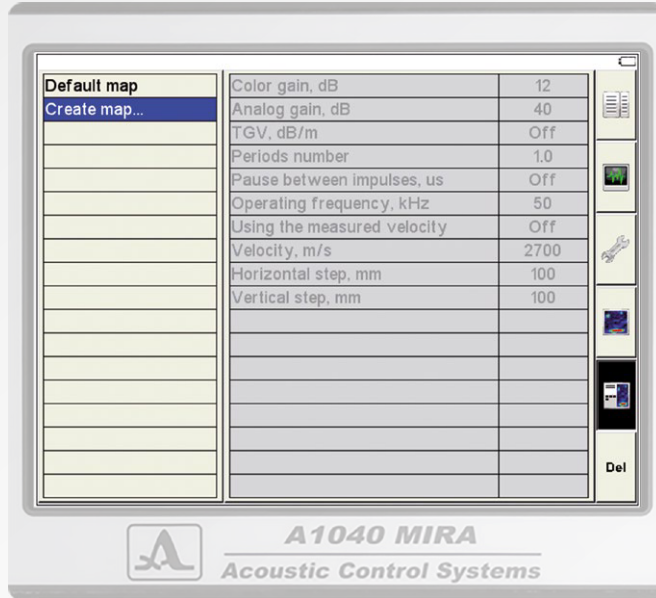



Figure 25

Figure 26

In default it is suggested to save the map under "the default" name with the serial number addition. It is possible to enter any appropriate name for any map (Figure 27).

To save the generated name, please press the key . The map with the new name will appear in the list (Figure 28).

1



Figure 27

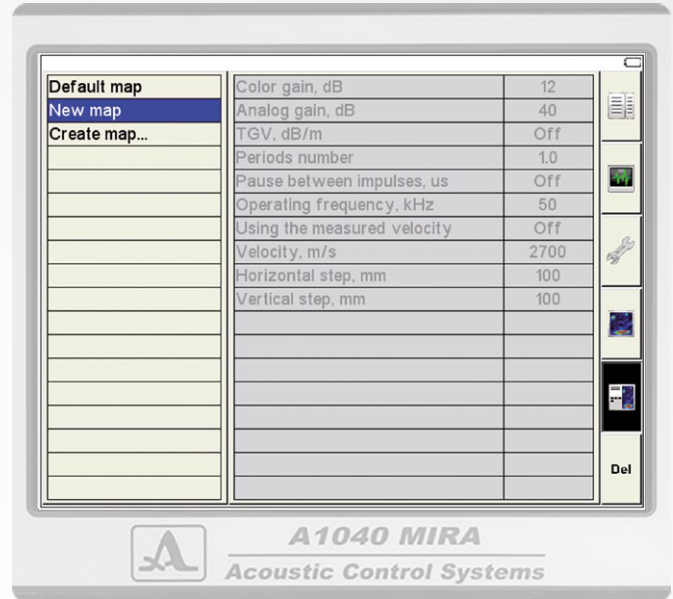
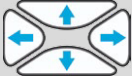





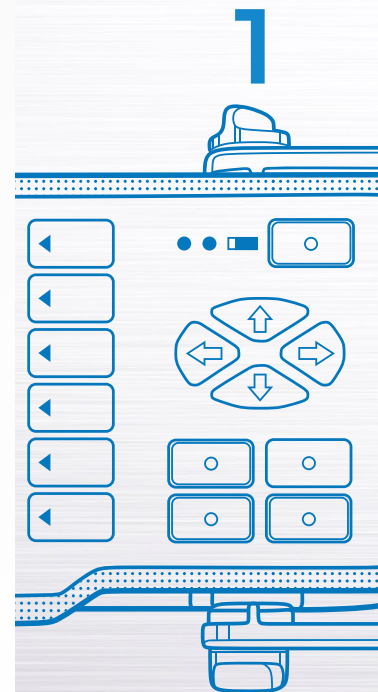

Figure 28

The functions of the keys during the name editing are shown in the Table 9.

Table 9











Key	Description
	Moving on the keyboard field located on the screen
	Cursor moving in the name field the left / to the right
	Entering a letter in the field /performing the action allocated to the key on the screen
	Entering symbols in the name field using the keyboard
	Removing a symbol in front of the cursor in the name field
	Enter a point in the name field
	Enter a space in the name field

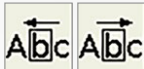

# 1



Functions of icons in the SETTING mode when editing the name are shown in the Table 10.

Key	Icon	Description
		Adjustment of parameters
 		Select gain and check the working capacity of the antenna array
		System options of the device
		Absence of the B Scans saved / Review of B-Scans parameters saved in memory of the device
		View the existing and create new MAPS

## 1.4.2 REVIEW mode

The mode is used for on-line viewing of the internal structure of the tested object in any place. When of B-scans appear, it is possible to estimate the correctness of device options.

The mode should be used before the consecutive data collection in the CARD mode.

The mode includes the following operations: after the installation of the device in a determined place of the tested object the B-scan image will be generated and displayed. To check the device options, please install the device in those places where the internal structure of tested object is known, and it is possible to check the correctness of the constructed section. The steps can be repeated infinitely.

On the screen the included A-scan is displayed, see Figure 29.

The functions of the keys in the REVIEW mode are given in the Table 11. The functions of the icons in the REVIEW mode are given in the Table 12.

Table 11



Key	Description
	Moving the cursor horizontally and vertically
	Enter the MAP mode
	Enter the MENU mode

Table 12





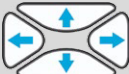



Key	Icon	Description
 		Increasing / reduction the brightness gain
 		Zoom in / Zoom out
		Saving the flowing B-Scan in the memory
		No of the B-Scans saved / Open and review the B Scans on the screen

Figure 29

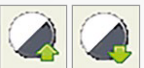

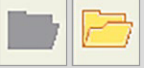
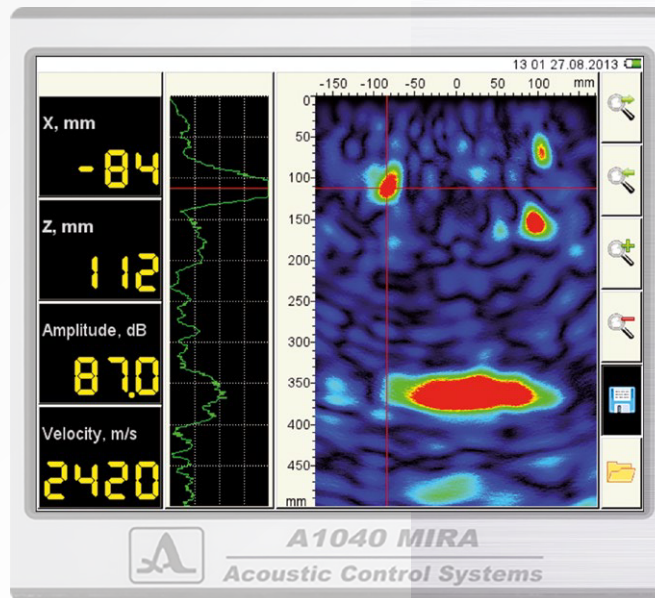

# 1

## 1.4.3 MAP mode

The mode is used to collect automatically save the data on the tested object, together with current settings of the system. The indication of B-Scans images generated with the received data is also possible.

Make sure that the B-Scans collected in the REVIEW mode are correct, after that you may use the MAP mode.

On the screen only the images of B-Scans received in current position of the device are shown. In the memory of the device the received signals and system options are registered automatically.

For switching between the modes, press **Enter**.

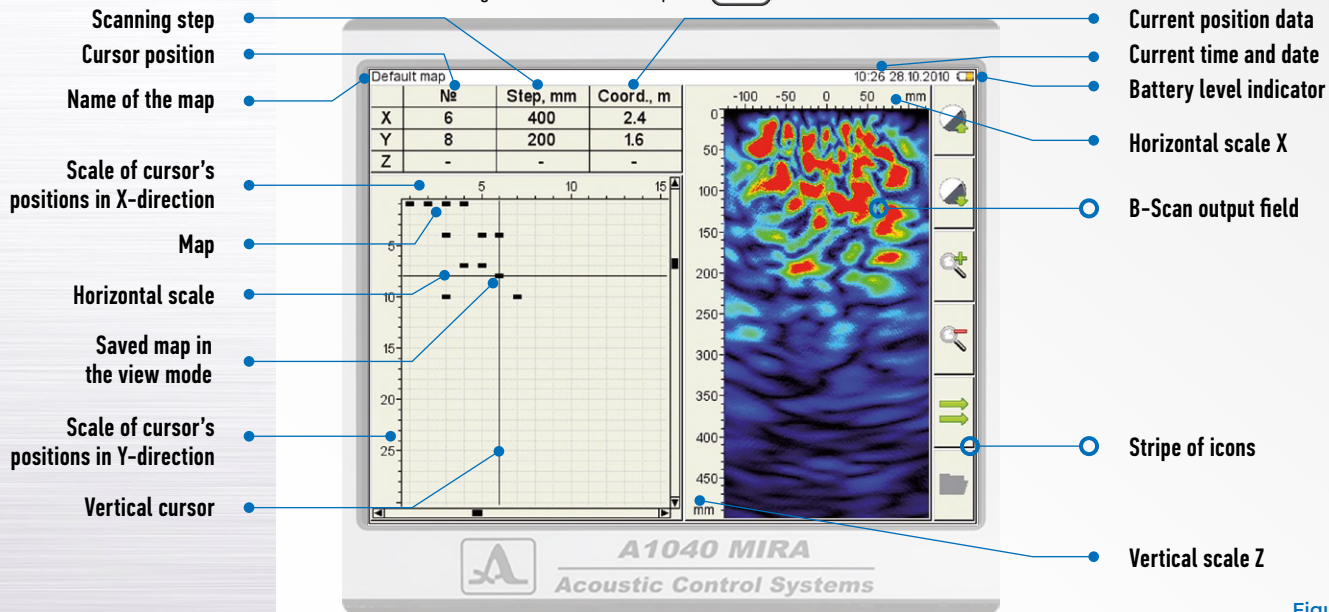

Figure 30



After switching on the mode, the screen window with graphic results from the MAP mode opens, it is similar to the window in the REVIEW mode where the images of B-Scans and the mode of MAP control panel are shown (Figure 30).

The functions of the keys in the MAP mode are shown in the Table 13.

The functions of the icons in the MAP mode are shown in the table 14.

Table 13











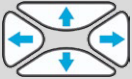





Key	Description
	Moving the cursor horizontally and vertically in the map field
	Enter REVIEW mode
	Enter SETTING mode

Table 14

Key	Icon	Description
 	 	Increasing / reduction the brightness gain
 	 	Zoom in / Zoom out
	 	Change the scanning direction
	 	No saved maps / Open and view the B Scans maps in the memory



## 1.4.4 Viewing the saved data

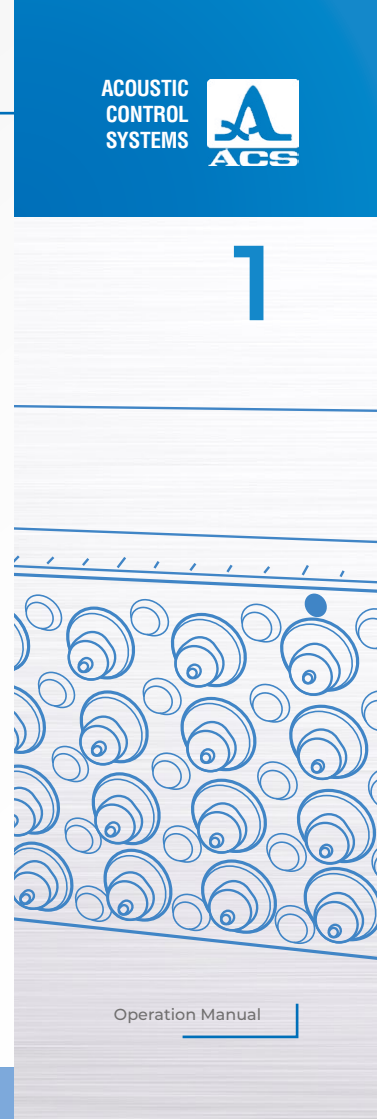

For viewing the saved data, please to press a key (◀ F6) in the REVIEW or the MAP mode corresponding to the icon . The screen B-scans saved in the REVIEW mode are shown in the Figure 31. The functions of the keys for viewing the saved B-scans are shown in the Table 15.

Table 15

Key	Description
	Moving of the cursor horizontally and vertically in the field of a B-scan
	Exit viewing the saved B-scans



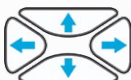

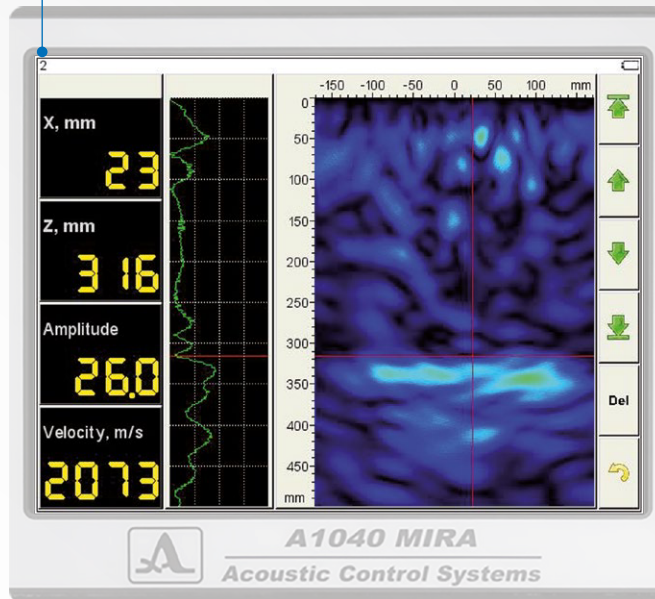





Name of the saved B-Scan

Figure 31



The functions of the icons for viewing the saved B-Scans are given in Table 16.

Table 16

Key	Icon	Description
		Go to the first saved B-scan
		Go to the previous saved B-Scan
		Go to the following saved B-Scan
		Go to last saved B-Scan
	<b>Del</b>	Remove the current B-Scan
		Exit viewing the saved B Scans

1

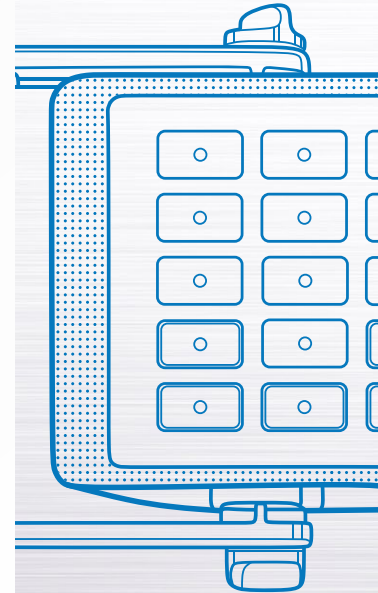



# 2

## PROPER USE

## 2.1 OPERATING RESTRICTIONS

The device is intended for operating conditions listed in the Section 1.1.2

## 2.2 PREPARING FOR OPERATION

### 2.2.1 Possible use of the tomograph

There are two possibilities of inspection of objects using the tomograph: local and continuous testing.

#### 2.2.1.1 Local testing

When performing the local testing mode, the device is placed in any place on the surface of the inspected object. Here it is possible to analyse the internal structure and the cross section in a specific place. Based on the results it is possible at once to receive the necessary information or to choose a direction where it is better to move the device to receive a more complete information.

#### 2.2.1.2 Continuous testing

Continuous testing is made step-by-step by moving the device continuously with further imaging and saving of the results. The direction of movement and the displacement step of the device is defined earlier and does not vary in a testing current, regardless the images received on the screen.

The continuous testing is used for complete inspection of the area of the tested object, with further modeling of the internal structure and saving the data, if necessary. The continuous testing is a long procedure which needs the tested object to be marked with a pattern before starting the testing. In order to check the working capacity of the device, it is highly recommended to test the instrument in the local testing mode.

### 2.2.2 Setting procedures

The tomograph is delivered ready for operation, no further adjustments are needed.  
Before starting the work, please charge the battery.

### 2.2.2.1 Preparation of the surface of the tested object

To prepare the surface of the tested object, please clean the areas, where the device will be installed, remove all dust and sand and the materials disturbing to penetration of low-frequency ultrasonic waves. Any layers other than concrete, such as polymeric or waterproofing materials or a thick paint coating on physical properties can negatively influence the work of the tomograph.

No contact liquid is necessary for the operation of the device.

Even and smooth surface of the inspected object gives a better acoustic contact for the device elements with a surface and therefore improves the quality of the image. Thus, it is necessary to choose whenever possible more even and smooth surfaces. It is possible to work with the roughness of the surface up to 8 mm, however, it is better to make the uneven surface smooth.

### 2.2.2.2 Creating a scanning pattern and treatment of the surface of the tested object

Prior to start the inspection it is necessary to mark the tested object. The pattern of tested object shows where and how to place the antenna array. Correctly made pattern accelerates the process of the data collection and simplifies the understanding of the inspection results.

When performing the local testing it is necessary to mark the places where the device will be placed.

When performing the continuous testing a more detailed marking is required. The surface of object should be divided into sections (horizontal and vertical lines) with the constant step (100 mm is the most effective) which is set in the menu. Lines are drawn on the surface of the testing object with a ruler and chalk.

After marking the tested object, it is possible to start the inspection.

### 2.2.2.3 Switching on the device

The device is switched ON using the key  on the front panel.

**NOTE: THE DEVICE IS SWITCHED ON WITH A SHORT DELAY. AFTER PRESSING THE KEY  THE PROMPT WILL APPEAR ON THE DISPLAY IN 10 SECONDS. A REPEATED PRESSING OF THE KEY  IN THESE 10 SECONDS LEADS TO THE SWITCHING OFF.**

After the device is switched on the green LED on the device antenna is on.

# 2

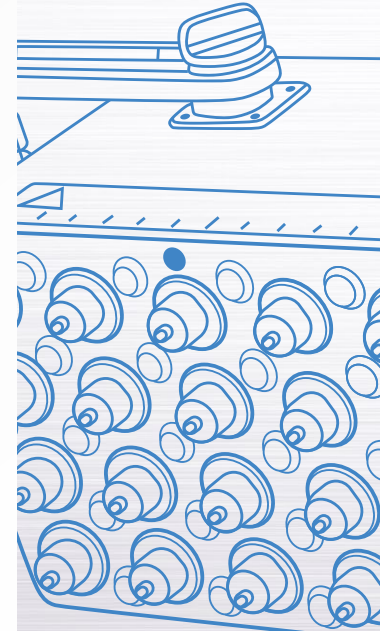



# 2

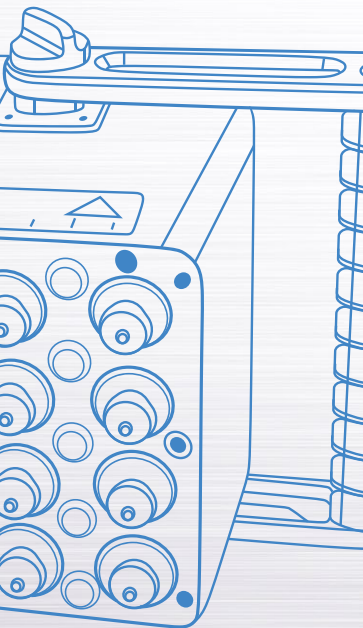

## 2.2.3 Performing the testing

### 2.2.3.1 Performing the local testing

To perform the local testing, please use the REVIEW mode.

Please place the device in proper areas of the inspected surface and press the trigger button. Further it is necessary to study the received image of the section and to draw a conclusion, whether the received data is enough for decision-making or where it is necessary to remove the device for more detailed information. The data received in this mode are not automatically recorded, therefore, if necessary, it shall be written down manually, as separate shots. To review the saved data, it is possible to load them into the REVIEW mode.

After receiving the necessary information to make a decision, the work in this mode can be finished.

### 2.2.3.2 Performing the continuous testing

To perform the continuous testing, please use the MAP mode.

Please place the device on the area, marked on the inspected object and press the trigger. Then move the device to the next position. The currently marked pattern is inspected this way and further all marked patterns are inspected.

When receiving first images shown in the screen, preliminary conclusions about the inspected object can be done. It is necessary to do the final conclusions on a PC after all the necessary data are received and processed by the software.



## 3.1 REGUL R M INTEN NCE

Please remove the accumulated dust and dirt from the external surfaces of the device, wipe it with a dry or a damp cloth or a napkin. Please remove the accumulated dust, dirt and foreign matter from the sockets and clean them with a soft brush.

In case of pollution of ceramic covers or transducers the ultrasonic contact with the tested object is possible. Please regularly check the parts of the device and clean the ceramic covers with a cloth moistened with spirit.

## 3.2 REEST BLISHING THE FUNCTION LITY OF THE DEVICE

### 3.2.1 Reestablishing the functions



In case the device does not operate correctly, there is no image or signals, error messages on the screen or after a long downtime and other events it is necessary to switch off and then switch on the device. If it does not help, please contact the service center of the manufacturer by e-mail: [info@acs-international.com](mailto:info@acs-international.com) or phone: **+49 681-9659-2270**.

### 3.2.2 Possible malfunctions

In the table 17 the malfunctions are shown that can be solved by the operator.

If the measures did not lead to normal operation, please contact the manufacturer by e-mail: [info@acs-international.com](mailto:info@acs-international.com) or phone: **+49 681-9659-2270**.

Table 17

Signs	Possible reasons	Troubleshooting
The device does not switch on	Error in memory of the device	Switch on the device as follows: 1. press the key  for several seconds 2. press the key 

# 3

## TECHNIC L M INTEN NCE



# 4

## STOR GE

Please store the device in the transport suitcase in a dry room according to generally accepted storage conditions. The storage room shall be free from the current-conducting dust, mixtures of aggressive gases and corrosive vapors able to lead to corrosion and destroying its isolation.

The device in the transportation suitcase with all accessories can be transported by the railway, motor transport and in heated plane compartments according to generally accepted transportation conditions.

During the transportation please make sure to protect the device against the atmospheric precipitation and blows. Arrangements should be made to provide steady position of the device during transportation.

# 5

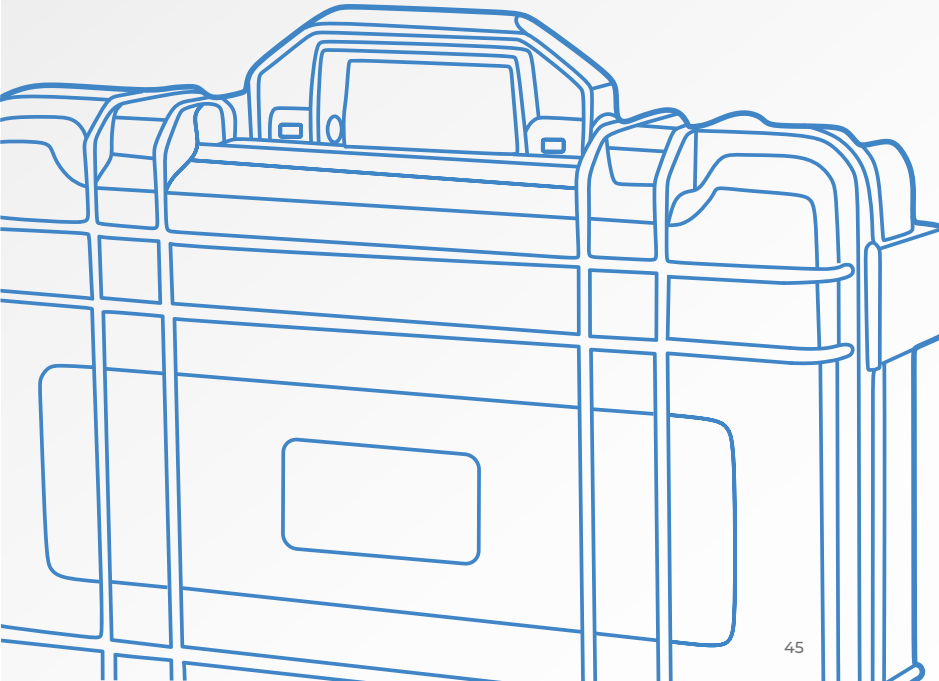



## NOTES



# A1040 MIR Low-Frequency Ultrasonic Tomograph



OPERATION MANUAL

Revision: February 2018