



A1410 PULSAR

Ultrasonic pulse velocity tester

Operation manual

Revision 1.2.0

Acoustic Control Systems - ACS Group
Saarbrücken, Germany 2021

This instruction manual contains essential information on how to use this ACS product safely and effectively. Before using this product, thoroughly review this instruction manual. Use the product as instructed.

1. Powering	3
2. Getting started	8
2.1 Powering on	8
2.2 Instrument check	9
2.3 Measurement scheme	9
3. Operating modes	12
3.1 Setup mode	13
3.2 Digital mode	23
3.2.1 Group/cell control	25
3.3 Waveform mode	28
3.4 Crack mode	30
3.4.1 Crack detection	31
4. Applications	38
4.1 Signal quality	38
4.2 Core testing	39
Index	0

1 Powering

This chapter describes how to operate the A1410 PULSAR using different power supply options.

Power indicator

The power indicator **1** is always present in the right top corner of the screen, Figure 0. It shows the level of the battery charge and whether it is being charged.

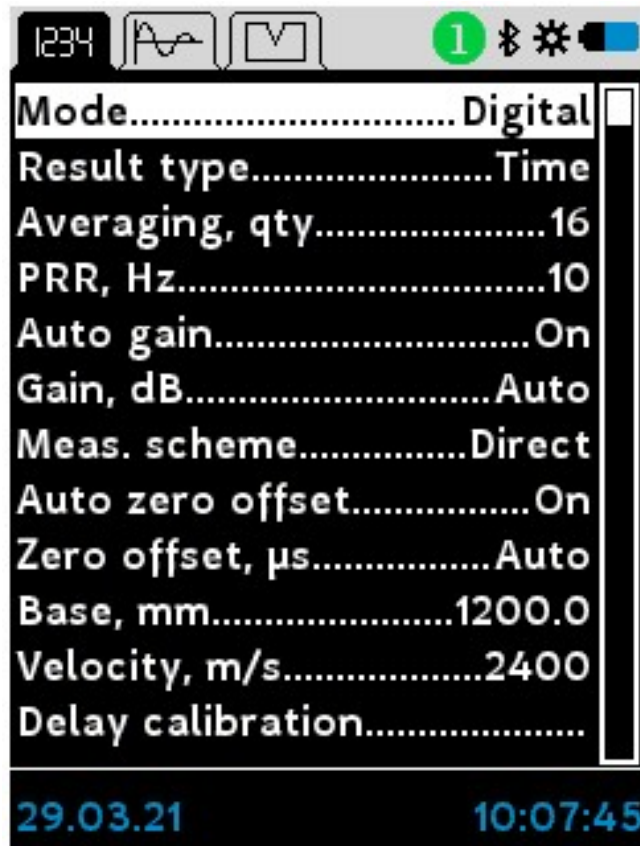















Figure 1: Power indicator

The power indicator takes one of the states denoted by the following icons.

Symbol	Description
	battery operation (100% remaining charge)
	battery operation (90% remaining charge)
	battery operation (80% remaining charge)
	battery operation (70% remaining charge)
	battery operation (60% remaining charge)
	battery operation (50% remaining charge)
	battery operation (40% remaining charge)
	battery operation (30% remaining charge)
	battery operation (20% remaining charge)
	battery operation (10% remaining charge)
	battery charge level is almost empty. The A1410 PULSAR will shut down soon.
	charging the battery. Do not disconnect AC charger/adaptor until the battery is fully charged.
	battery alert. The environmental temperature is less than 0 centigrade. The battery does not charge
	battery alert. The environmental temperature exceeds 60 centigrade. The battery does not charge.

NOTE

The environmental temperature influences the battery charging time. At the temperature between 0 and 15 centigrade, only half of the total current passes to the battery. The standard charging is between 15 to 45 centigrade. At a temperature between 45 to 60 centigrade, the battery uses up to 85% of its capacity.

Using the AC Power

You can operate the A1410 PULSAR with the AC power using the USB-AC charger. The charger works with any line voltage 100-240 VAC at frequencies 47 Hz to 63 Hz.



CAUTION

To avoid the risk of injuries or equipment damage, use only the USB-AC charger and corresponding USB-Cable delivered with the A1410 PULSAR.

To use AC power connect the USB-Cable ① to the charger ② and the instrument. Plug the charger to the power supply network, Figure 1:

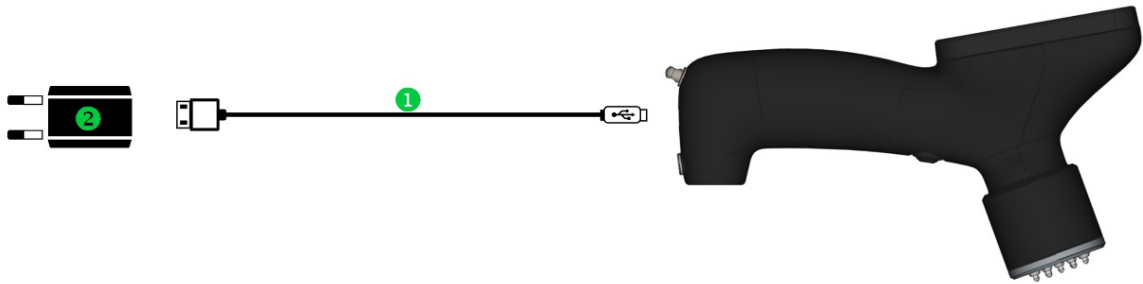

Figure 2: Charging over USB-AC charger

Using PC USB-plug

For charging using PC ① connect the A1410 PULSAR to PC's standard USB-plug, Figure 2:

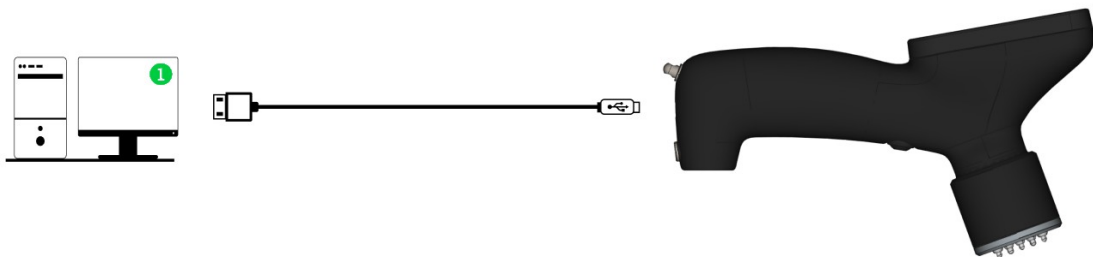



Figure 3: Charging over PC USB-plug

NOTE

If the A1410 PULSAR is off, it indicates charging showing  on the screen.



WARNING

Charge the A1410 PULSAR over USB-AC charger or PC USB-plug as it is described above. Not following the description may damage the A1410 PULSAR

Using Battery Power

The A1410 PULSAR comes with a rechargeable lithium-iron phosphate (LiFePO₄) battery with 3000 mA/h. The A1410 PULSAR automatically recharges the battery when you connect the instrument to the AC power.

Battery Operating Time

The battery operating time depends on the age of the battery and the instrument settings. To provide realistic battery operating times, the A1410 PULSAR has been tested with mid-level operating parameters (repetition rate set to 5 Hz and display brightness set to 75%). The nominal battery operating time for new batteries is about 14-16 hours.

Charging the Battery



WARNING

The AC-USB charger and the USB-Cable were tested to charge the A1410 PULSAR batteries only. Do not attempt to charge any other battery types or use any other chargers/adapters to charge the A1410 PULSAR batteries. Doing so may cause an explosion and injury.

To charge the internal battery connect the A1410 PULSAR using the AC power or PC power (see description above). The battery charges when the instrument is ON or OFF, but the rate of charge is slower when the instrument is ON.

NOTE

When the battery is fully charged, the battery charging symbol shows 100% remaining charge (full battery). It takes approximately 3 to 3.5 hours to fully charge a battery depending on its initial conditions.

NOTE

It may take several cycles of complete charging and discharging of the battery to bring the battery to full capacity. This conditioning process is normal for this type of rechargeable batteries

Battery Usage Instructions

- The battery must reach full charge on a regular basis for proper capacity and cycle-life maintenance.
- Fully recharge discharged batteries as soon as possible after use.

Storage Instructions

- Never store the instrument with discharged batteries.
- Store the instrument in a cool, dry environment.
- Avoid long-term storage under sunlight or in other excessively hot places such as the trunk of an automobile.
- While in storage, fully recharge batteries at least once every two months.

Replacing the Battery

**CAUTION**

Do not open the A1410 PULSAR housing and do not try to exchange or repair the battery. Doing so may cause damaging of the instrument or/and injury. If you experiencing any problems with the device, contact support.



2 Getting started

2.1 Powering on

Surface preparation

Clean the object surface at the transmitter and the receiver locations. It is sufficient to remove dirt, debris and sand. The surface, if possible, should be flat.

Measurement

- Switch on the instrument by pressing the  key. The display shows the welcome screen. Check for the version at the bottom of the screen. If necessary, update the A1410 PULSAR firmware. The A1410 PULSAR loads the parameters from the previous session and starts normally. Switch off the A1410 PULSAR by pressing the  key. The A1410 PULSAR turns off in 10 minutes automatically if no action has been done.

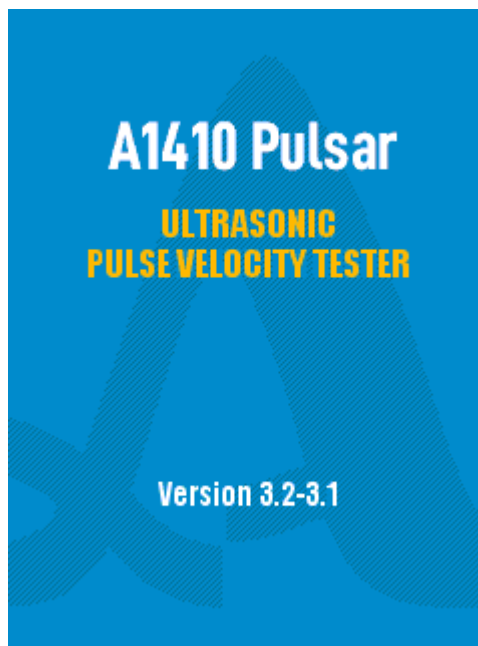

- Perform `instrument check`. For detailed description refer to [page 9](#).
- Set the required parameters in `setup mode`, refer to the description at the [page 13](#).
- Perform the measurement. Place the transmitter and the receiver at the desired locations according to the [measurement scheme](#) and press both firmly. Check the orientation of the transmitter and the receiver. Keep the pressing till the measurement ends. Do not move, rotate or shake the transducers while pressing. The progress bar shows the end of the measurement [process](#). Read the result. If the result is not satisfying, ignore the `saving dialog` by pressing the `enter` button two times. Read more about ignoring on [page 25](#).

- Save the result by pressing the `enter` button and the  key. Read more about saving on [page 25](#).

2.2 Instrument check

Instrument check

To check the instrument use the plexiglass calibration sample.

- Ensure the following parameters are correct (to more information on parameters refer to [page 13](#)): auto gain = on, measurement scheme = direct, auto zero offset=on, result type = time, mode = digital or waveform.
- Perform a measurement according to [to 9](#). Use the grooves at the sample's faces for exact instrument installation. The progress bar shows the end of the measurement process [see 23](#).

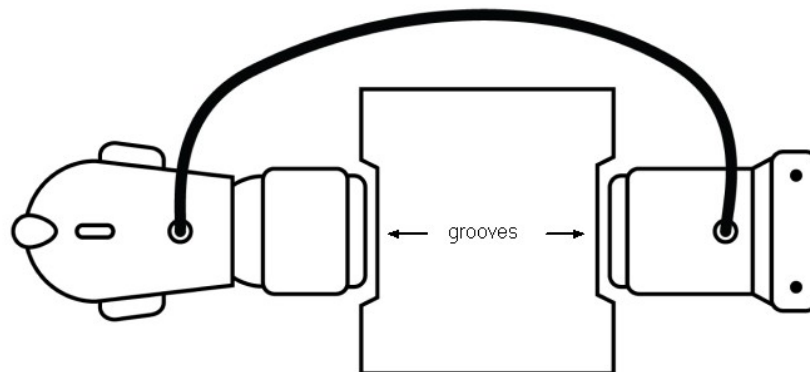

- Check whether the measured time fits the time interval printed on the calibration sample. In case the measured time is outside the interval, perform the instrument calibration. For more information on calibration, refer to [to 13](#).

2.3 Measurement scheme

The A1410 PULSAR support three measurement schemes. These are direct, semi-direct and indirect schemes.

NOTE

For more information about measurement schemes, refer to UPVT standards e.g. DIN EN 12504-4, BS 1881, C597 - 16, IS 13311-1.

Direct scheme

Figure 3 shows the transducers placed directly against to each other on opposite faces of the concrete. Where possible, the direct scheme should be used since the

transfer of energy between transducers is at its maximum. Hence the accuracy of velocity determination is therefore governed principally by the accuracy of the path length measurement.

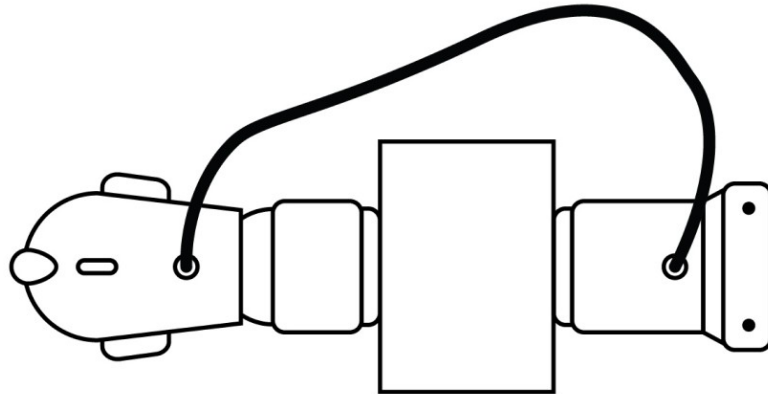

Figure 4: Direct scheme

Semi-direct scheme

The semi-direct scheme (Figure 4) may result in reduction in the accuracy of measurement of the path length. It is generally found to be sufficiently accurate to take this as the distance measured from center to center of the transducer faces. The semi-direct scheme also suffers from reducing of receiver sensitivity.

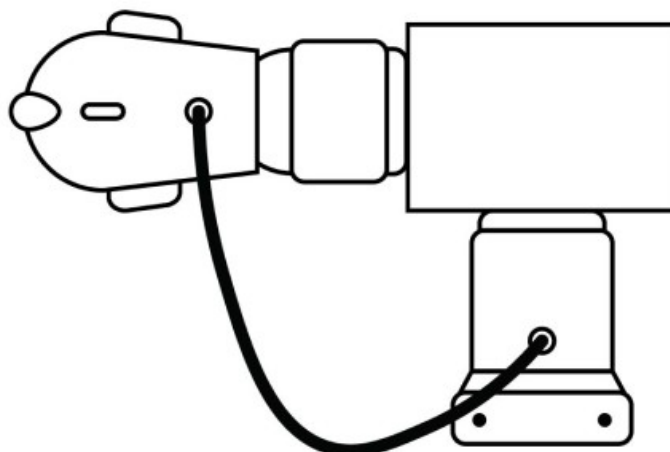

Figure 5: Semi-direct scheme

Indirect scheme

Indirect transmission scheme should be used if only one face of the concrete is accessible. It is the least sensitive of the arrangements and it depends on the distance between the transmitter and the receiver. Furthermore, this scheme produces measurements which are usually influenced by the concrete near the surface.

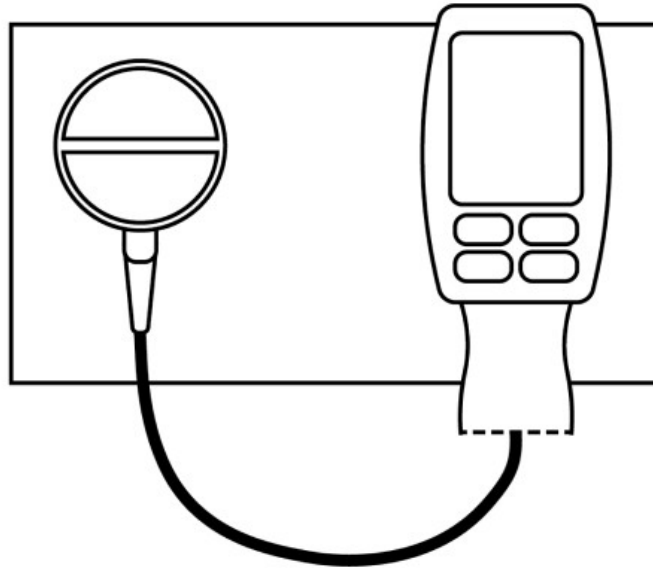

Figure 6: Indirect scheme



WARNING

Please confirm, the transmitter and the receiver orientation is correct. User LEMO connectors for visual alignment.

3 Operating modes

Short description

The A1410 PULSAR is operating in following operation modes: setup, digital, waveform, and crack.

- In the `setup` mode, the operator adjusts the measurement settings. Press the  key to enter the `setup` mode.
- In the `digital` mode, the operator reads measured values on a numeric display. The display takes more than half of the screen - this simplifies reading the values at a distance.
- In the `crack` mode the A1410 PULSAR estimates the depth of the crack.

Status bar

The status bar provides the information about the A1410 PULSAR state. It takes up the top line of the screen, Figure 6

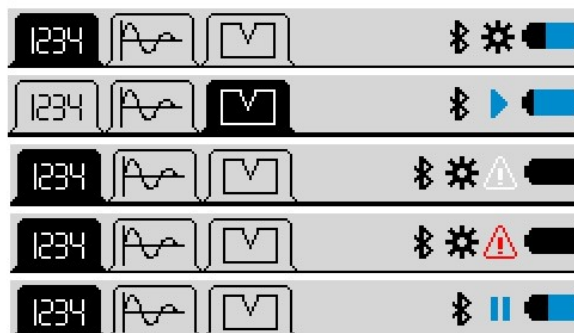













Figure 7: Status bar examples

The following table lists the descriptor of symbols of the progress bar:

Icon	Description
	Digital mode is active
	Digital mode is not active
	Waveform mode is active
	Waveform mode is not active
	Crack mode is active
	Crack mode is not active
	Setup mode is active
	The instrument is measuring. The transmitter emits the pulse, whereas the receiver is waiting for the signal
	The instrument is not measuring. The transmitter does not emit pulses
	Bluetooth interface is activated
	Power state indicators, for more information see page 31

3.1 Setup mode

The `setup` mode provides tools and instruments for:

- editing of instrument settings
- choosing measurement modes
- calling the calibration routines

To enter the `setup` mode press the  key. The screen of the `setup` mode has two areas: the list of settings and the time/date indicator (located at the bottom part of the screen), Figure 7.

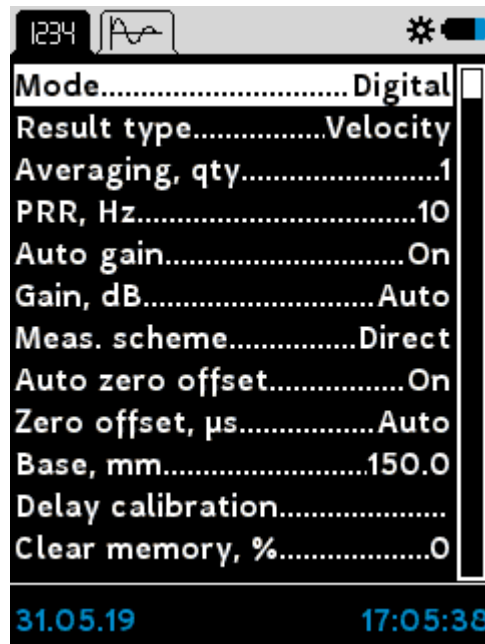

Figure 8: SETUP mode screen

The following table describes functions of the instrument keys in the `setup` mode.

Keys	Functions
<div style="display: flex; flex-direction: column; gap: 5px;"> <div style="border: 1px solid gray; padding: 2px; text-align: center;">↓</div> <div style="border: 1px solid gray; padding: 2px; text-align: center;">↑</div> </div>	<ul style="list-style-type: none"> • Selecting of the item to be edited. The selected item becomes highlighted, Figure 8. • Confirmation of an action with yes/no • Changing the setting value
enter	<ul style="list-style-type: none"> • Selecting parameter for editing • Saving new parameter value

Mode



The `mode` sets the operational modes of the A1410 PULSAR. There are three modes: [digital](#)^[23], [waveform](#)^[28], and [crack](#)^[30]. For more information, refer to the corresponding sections of the manual. Change the `mode` by pressing the `enter` button.

Result type

The `result type` switches between different kinds of outputs. These are `time`, `velocity`, and `path`. Change the `result type` by pressing the `enter` button. For information, refer to the description of `base` and `velocity` parameters later in the section. Find screenshots of `digital` and `waveform` modes for different `result type` on [page](#)^[23] [and](#)^[28].

Averaging

The `averaging` defines number of waveforms to be acquired within a single measurement cycle. The A1410 PULSAR computes the result out of the averaged waveform. `Averaging` factor 16 is optimal in terms of measurement time and accuracy/reliability of the result. Increase the `averaging` factor in case of strong concrete attenuation, presence of structural material noise, or other disturbances. The `averaging` takes following values: 1 / 2 / 4 / 8 / 16 / 32 / 64.

Activate the editing dialog by pressing `enter` button (Figure 8). Use the   keys to change the value. Press the `enter` button to close the dialog.

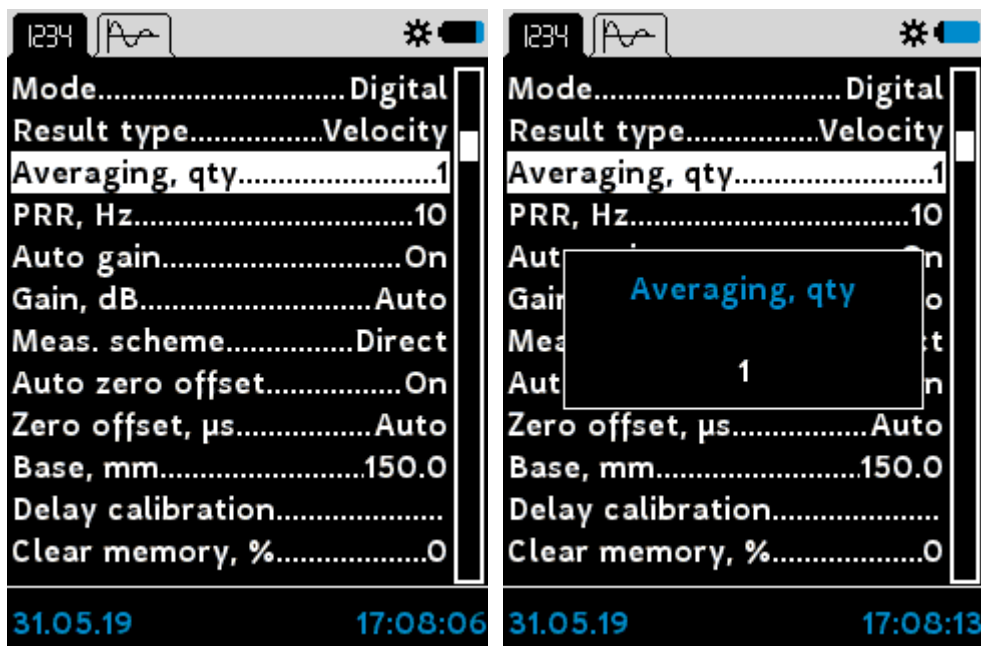

Figure 9: Editing averaging

PRR

The `PRR` (pulse repetition rate) defines the number of transmitter pulses emitted within one second. The total measurement time is `averaging/PRR`. A high `PRR` speeds up the measurement, whereas a low `PRR` slows it down.

Adjust the `PRR` by taking into account two following considerations:

- Small concrete objects (at least one dimension is less than 300mm) may introduce residual sound. If `PRR` is small, this sound can disturb the measurement by overlapping with a new transmitter pulse. These disturbances are also called "ghost echoes".
- Concretes with low attenuation factor may also introduce "ghost echoes" since the ultrasound needs more time for dissipation.

The operator can set the `PRR` value from 2 to 25. The editing of the `PRR` is similar to edition of the `averaging`.

Auto gain



The `auto gain = on` forces the A1410 PULSAR to adjust the analog `gain` automatically. With this, the A1410 PULSAR takes care that the measured signal does not exhibit a saturation. If `auto gain = off` the A1410 PULSAR expects the `gain` to be edited manually. It is of good practice to set `auto gain = on`. However, in rare cases, the estimation of the attenuation is mandatory. In such a case, the operator can observe the signal's amplitude for a given `gain` over different samples. Edit the auto gain by pressing the `enter` button.



Gain

The `gain` sets the A1410 PULSAR analog gain between 40 and 80 dB with a step 2. The editing of the `gain` is allowed if `auto gain = off`. The editing of the `gain` is similar to edition of the `averaging`.

Measurement scheme

There are three `measurement schemes` available. The schemes differs in respect to arrangement of transmitter and receiver.

- Direct  scheme. The transmitter and the receiver are located on the opposite sides of the inspection object;
- Semi-direct  scheme. The transmitter and the receiver are located on adjacent sides of the inspection object;
- Indirect  scheme. The transmitter and the receiver are located on the same side of the inspection object.

Press the `enter` button to show the editing dialog. Use keys   to select the desired scheme (Figure 9):

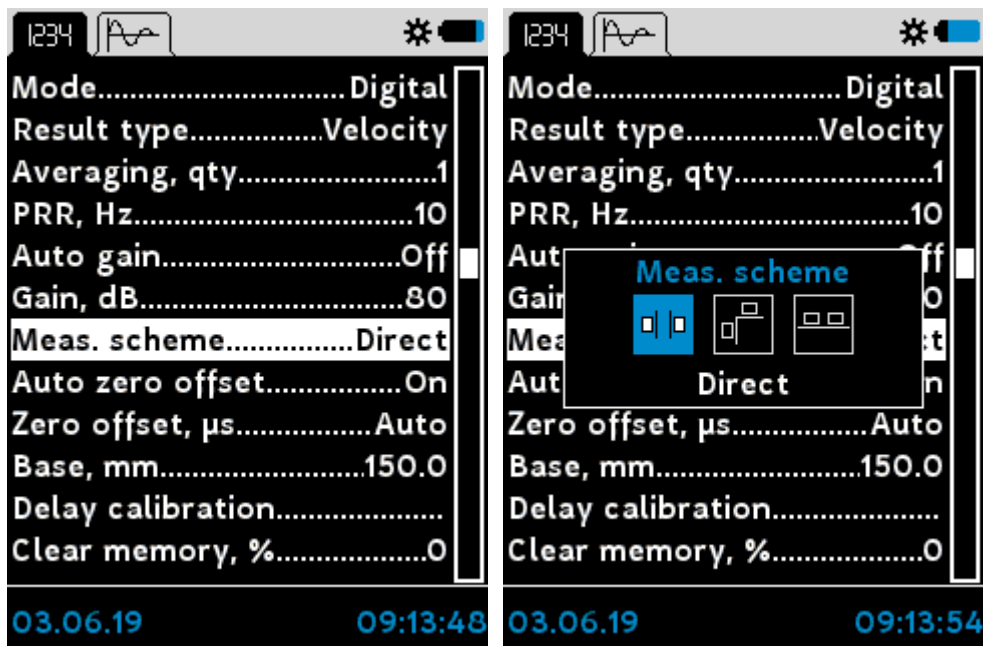

Figure 10: Measurement scheme

NOTE

For more information about measurement scheme, please refer to [page 9](#)

Auto zero offset

The actual recording buffer length of A1410 PULSAR does not exceed 200µs. It corresponds to ca. 0.9m concrete (at the velocity = 4500m/s). To increase the inspection depth up to 2500m the A1410 PULSAR uses the recording delay called zero offset. There are two ways to set the zero offset, namely, automatic and manual. If auto zero offset=on the A1410 PULSAR initiates an additional exploring pulse, measures the pulse arrival time and computes zero offset automatically. If auto zero offset=off the A1410 PULSAR does not emit the exploring pulse but starts recording from zero offset specified by the operator. The table setting zero offset in relation to depth range is described in the next section. Edit the auto zero offset by pressing the enter button.

NOTE

Use auto zero offset=on as a first option. If the result does not fit the expectations, switch to auto zero offset=off and specify the zero offset. Probably, there are some signal interferences or environmental noise influencing the pulse detection.

Zero offset

The following table shows the relation between *zero offset* and range from/to. The depth range corresponds to sound velocity equal to 4500m/s.

Zero offset, μs	Depth range, m	
	from	to
0	0	0.9
50	0.225	1.125
100	0.45	1.35
150	0.675	1.575
200	0.9	1.8
250	1.125	2.025
300	1.35	2.25
350	1.575	2.475
400	1.8	2.7
450	2.025	2.925
500	2.25	3.125

Figure 10 demonstrates two screens with *zero offset*=0 μs /base = 450mm (left) and *zero offset* = 150 μs /base = 120mm (right). Editing of *zero offset* is similar to editing of the averaging.

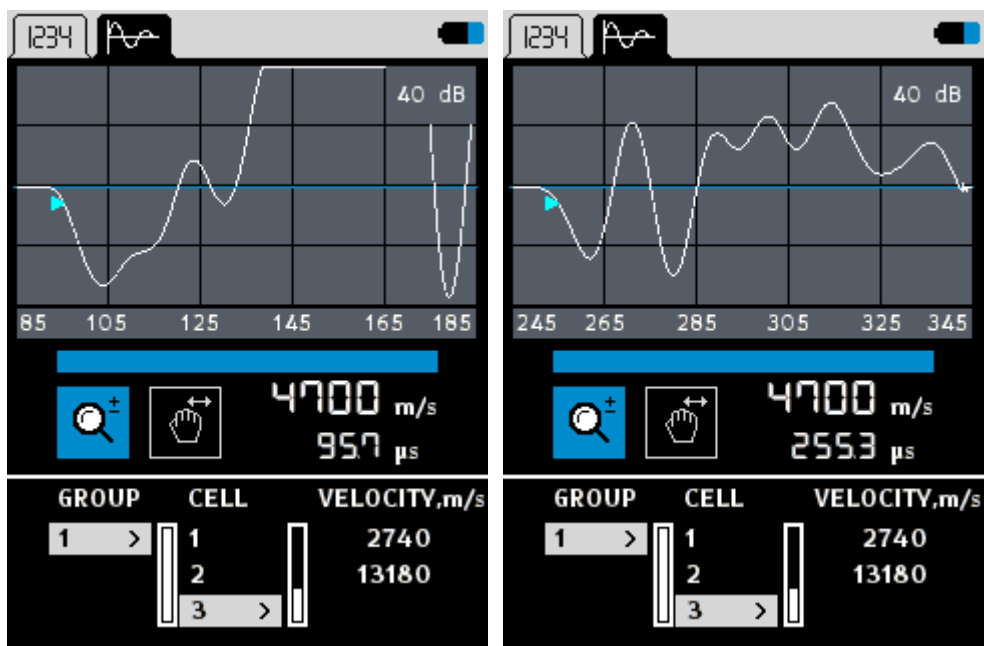





Figure 11: Zero offset example

Base

The `base` parameter defines the sound path expressed in mm or inch. If the `result type` is `time` or `velocity`, the A1410 PULSAR computes sound velocity through $\frac{base}{time}$. The `<%INSTRUMENT%` also uses the `base` for delay calibration. An attempt to change the `base` (enter button) results in a pop-up warning message shown on Figure 11. Confirm the editing using  . After conformation the editing dialog appears. Use the   keys to enter the `base` value. Finalize editing by pressing the `enter` button.

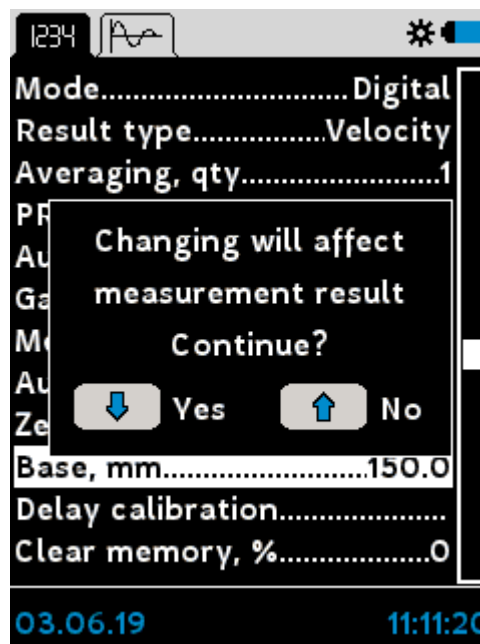

Figure 12: Attempt to change base parameter

Velocity

The `velocity` parameter defines the speed of sound in the material. If the `result velocity type` is `path`, the A1410 PULSAR computes the sound path through $\frac{velocity}{time}$. An attempt to change the `velocity` results in a pop-up warning message. Editing of the `velocity` is similar to editing of the `base`.

Auto search depth

Refer to [page 39](#) for auto search depth usage.

Search depth



Refer to [page 39](#) for search depth usage.

Delay calibration

Delay calibration routine estimates and saves a system delay of the A1410 PULSAR which consist of pcb-delay, cable delay, and transducer delay. Conduct the delay calibration on the reference specimen (plexiglass cylinder) supplied the A1410 PULSAR. Follow the following steps:

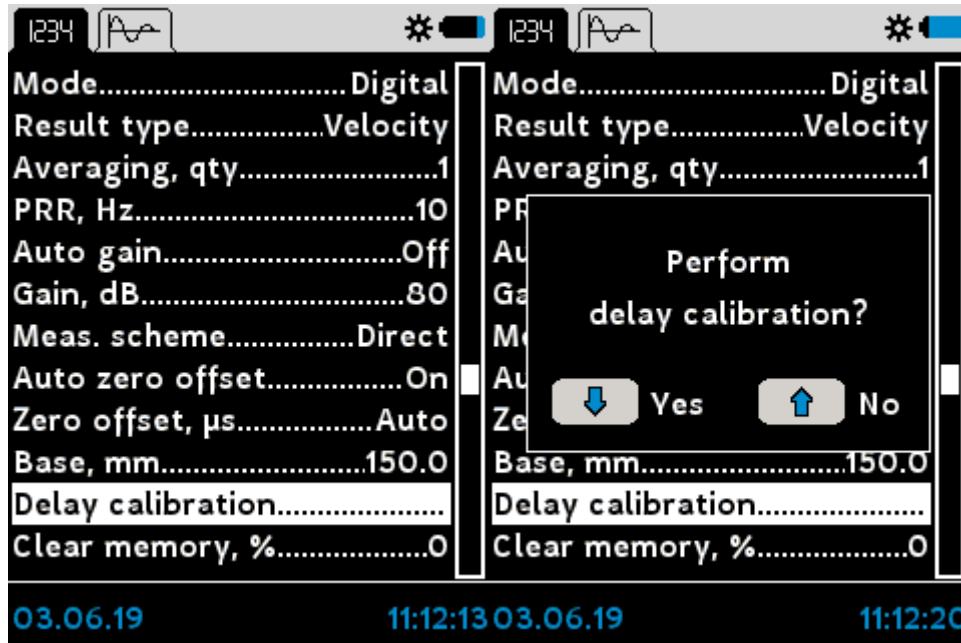
- Choose delay calibration, press `enter` button and confirm the calibration



- Set the propagation time written at the reference specimen using keys  . Confirm input by pressing `enter` button.

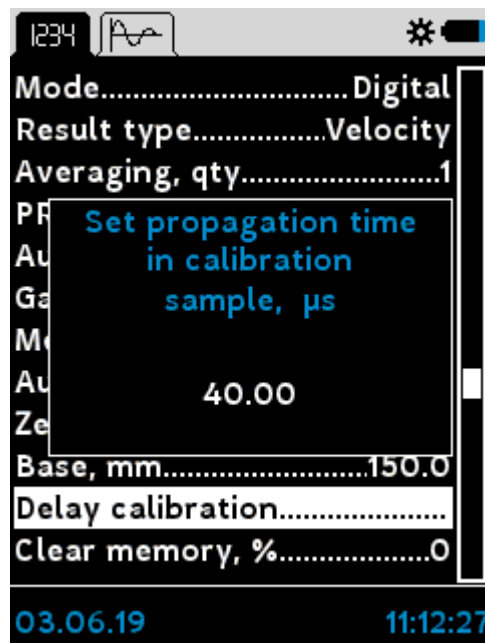

- Prepare for the measurements. Confirm your readiness by pressing `enter`. Refer to the [page 8](#) for checking out the measurement process.

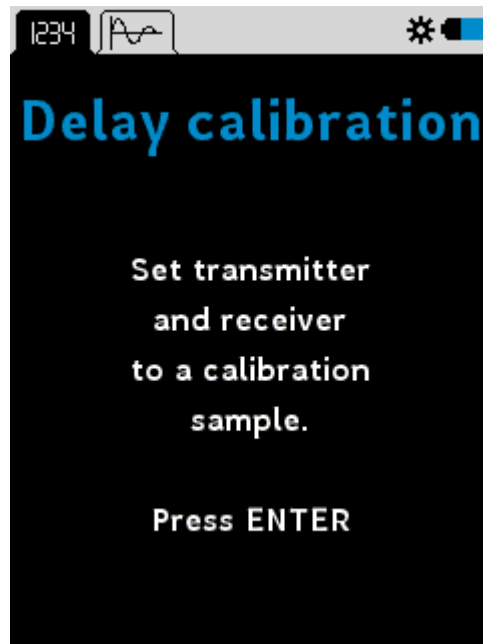

- Wait as long as the progress bar is running. Finalize the `delay calibration` by pressing `enter` button.

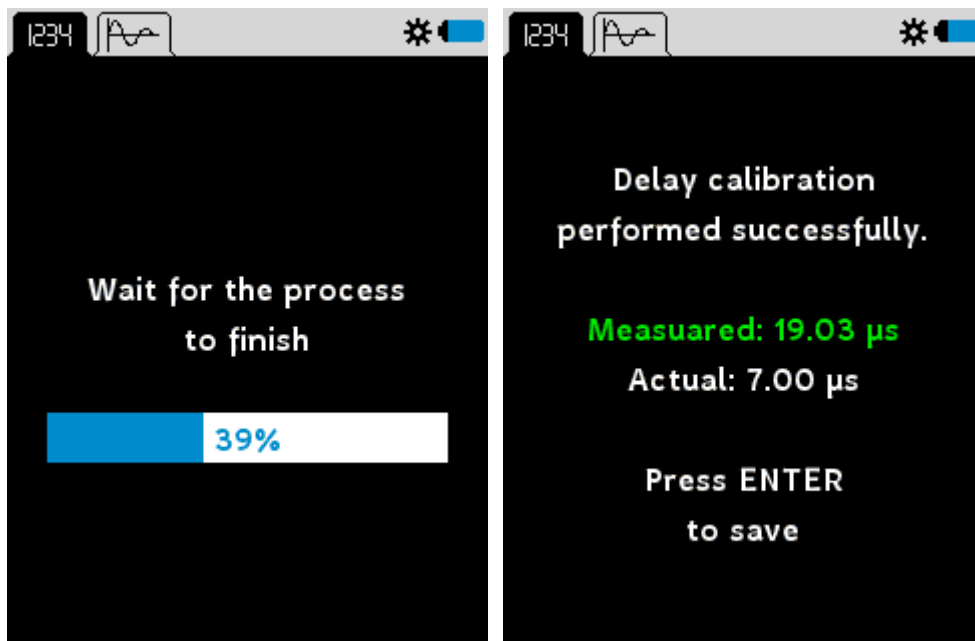



Please confirm the correctness of `delay calibration` by measuring the reference sample.

Bluetooth

The `bluetooth = on` activates the bluetooth communication interface. This interface allows the A1410 PULSAR communicate with the android app. Set the `bluetooth = off` to save battery charge.

Clear memory

Use `clear memory` to delete entries listed in the measurement table. The `clear memory` shows the amount of used memory in percentage. Press `enter` to initiate the cleaning procedure (Figure 12). Confirm or abort cleaning using the   keys.

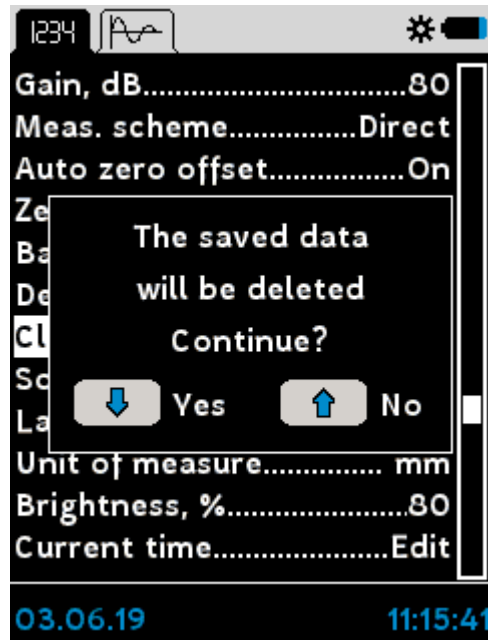

Figure 13: Clear memory

Sound

If `sound = on` the A1410 PULSAR beeps when you press any of the keypad keys, enter button, or the instrument finishes the measurement. Use the `enter` button for editing of the sound.

Language

Use `language` settings to switch between English, Russian and Korean languages. Use the `enter` button to change the `language`

Unit of measure



Use `unit of measure` to switch between metric (mm) and non-metric units (inch). For editing use the `enter` button.

Brightness

Use `brightness` to setup the brightness of the display in percents. Lower values of the `brightness` keep the battery charge longer. The `brightness` varies from 10% to 100%. Use the `enter` button to edit the `brightness`.

Current time

Use `current time` to set up the system time and the date. Press the `enter` button to start time setting (Figure 13). Select the parameter to edit (day, month, year, hours ,

or minutes) by pressing enter button until the parameter is highlighted red. Use the keys   to change the value. In order to finalize the editing press enter until the window disappears. Abort editing by pressing the  key.

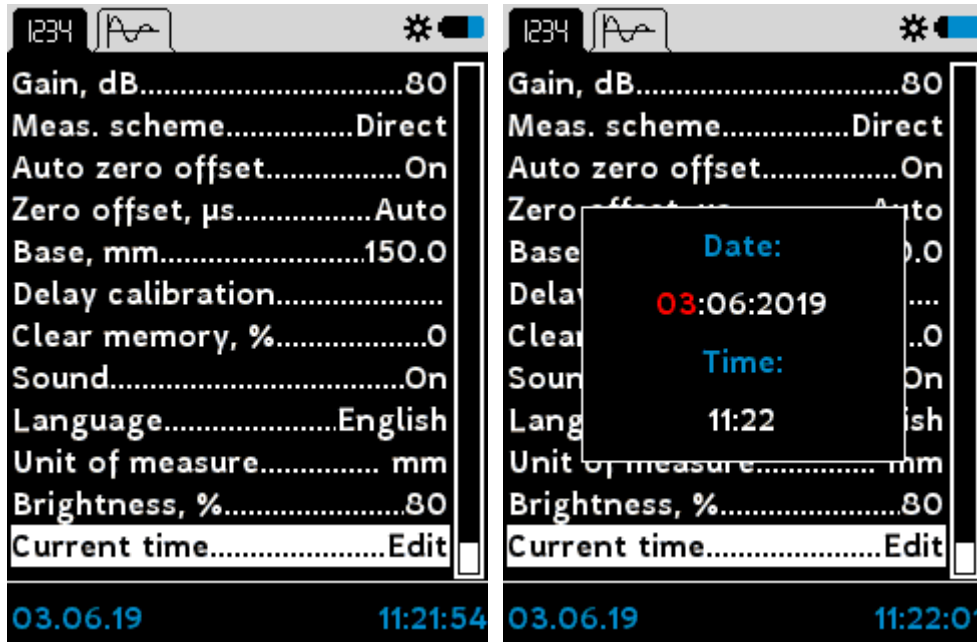

Figure 14: Current time

3.2 Digital mode

The digital mode shows measurement results in the form of a numeric indicator. This chapter describes the elements of the digital mode screen shown on Figure 14:

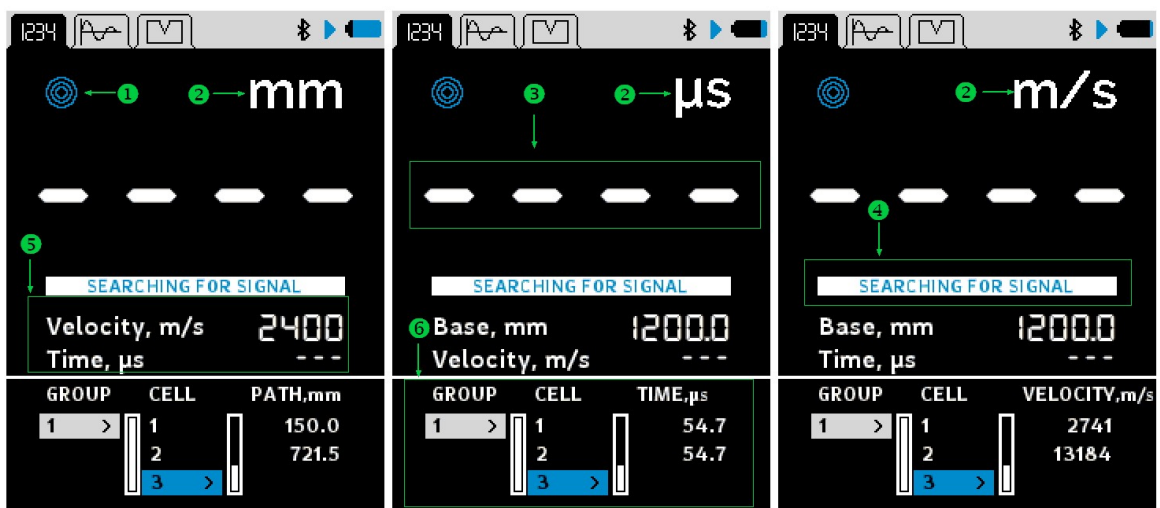







Figure 15: Digital mode screens

Quality indicator

The quality indicator **1** informs the operator about the quality of the acoustic contact. The indicator has the following grades:

Sym bol	Description
	The acoustic signal at the receiver exceeds the allowable level. Try to set the gain at a minimum. Measurements are not reliable.
	The acoustic signal at the receiver is optimal amplitude. Measurements are reliable.
	The acoustic signal at the receiver is almost optimal. Measurements are still reliable.
	The acoustic signal at the receiver is weak. Take some measurements to reduce an error.
	The receiver can not register any signal. Measurements are not possible.

Unit's indicator

Depending on the `result type`, the unit's indicator **2** informs the operator about the main measured physical quantity:

- m/s if `result type` = velocity
- mm if `result type` = sound path
- μ s if `result type` = time

Numeric indicator

The numeric indicator **3** takes the upper part of the screen. It indicates the value of a measured physical quantity.

Progress bar

The progress bar **4** indicates the current state of the measurements. The white progress bar with text `SEARCHING FOR SIGNAL` inside means the device is ready for measurements and waits for the receiver's signal. The filling blue progress bar indicates a running measurement. By the end of a measurement, the progress bar turns white again. The numeric indicator shows the last measured value.

Additional indicator

The additional indicator **5** depends on the selected `result type`. The indicator displays the following settings:

- user-defined `base` and detected time if the `result type` is velocity
- user-defined `base` and computed velocity if the `result type` is time

- user-defined `velocity` and detected time id the `result` type is `path`



3.2.1 Group/cell control

Results table

The A1410 PULSAR saves the results in its memory in cells ⑥. The cells form groups. The A1410 PULSAR indexes the groups and cells starting from one. The allowable number of groups and cells is 500 and 100, respectively.

If the index reaches its maximum, the device displays the corresponding pop-up message. It is a good practice to use smaller groups with several dozens of measurements. The operator can add a cell to any already existing group.

Navigation

Use the   keys to navigate along the table. Hold the keys to move the cursor between columns (groups, cells and values). Press the key shortly to move the cursor up or down within the column.

Add a new group

Navigate to the group's row (see figure 15). Select the last group and press the  key. The pop-up dialog ① asks permission to create a new group. The A1410 PULSAR creates a new group if the last group is not empty. If the last group is empty the A1410 PULSAR does not create a new group and shows the message ② .

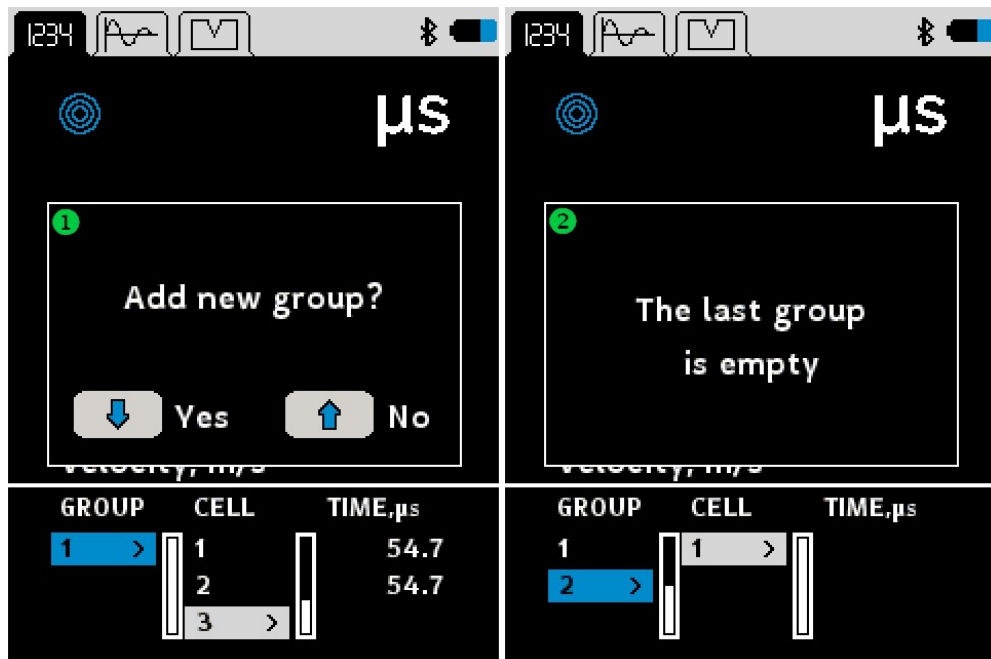



Figure 16: Add a new group

Add a new cell

Navigate to the cell's column. Select the last cell and press the  key. The A1410 PULSAR creates an empty cell. Perform the measurement and press the `enter` button

to save the result. The A1410 PULSAR creates a blank cell for the next measurement after saving.



View cells' values

The operator can view the cells' values within a group. While viewing, the A1410 PULSAR shuts down the transmitter and the receiver by moving to the wait state.

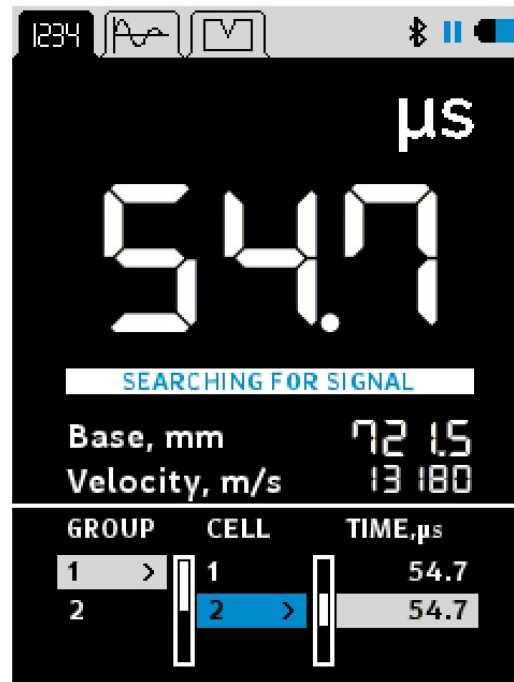
The A1410 PULSAR indicates the wait state with  at the right upper corner of the screen.







To view the cells:

- Navigate to the cell's column
- Use the   keys to navigate along cells.

Update the cell's value

The operator can update (or re-measure) a value of an existing cell:

- Navigate to the cells's column
- Use the   to select the cell
- Navigate to the cell's value by holding the  key. The A1410 PULSAR is ready for the measurement (the active icon  replaces the hold icon ) and waits for the signal on receiver.

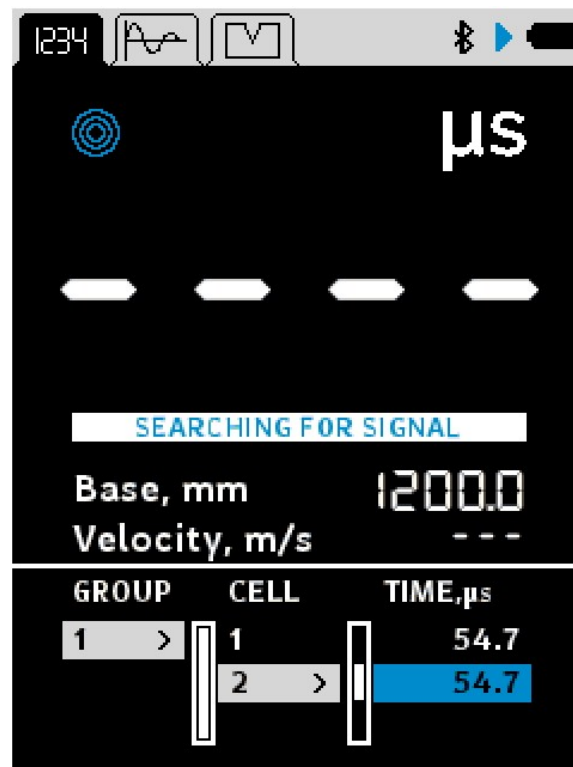



- Make the measurement and save the result pressing the `enter` button.

NOTE

The operator can cancel the update of the cell moving to the cell's column using the  key.

Saving results

At the end of the measurements, press the `enter` button. The pop-up dialog asks to save or to reject the result. Use the   keys to finalize the saving.

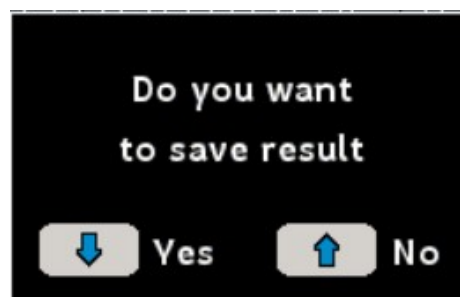

NOTE

The operator can reject the result by pressing the `enter` button while the saving dialog is active. The A1410 PULSAR is ready for the next measurement.

While saving, an out-of-range dialog may appear. It means the computed velocity (`result_type = velocity` or `time`) is out of the allowed range. The `base` parameter might be too high or too low.

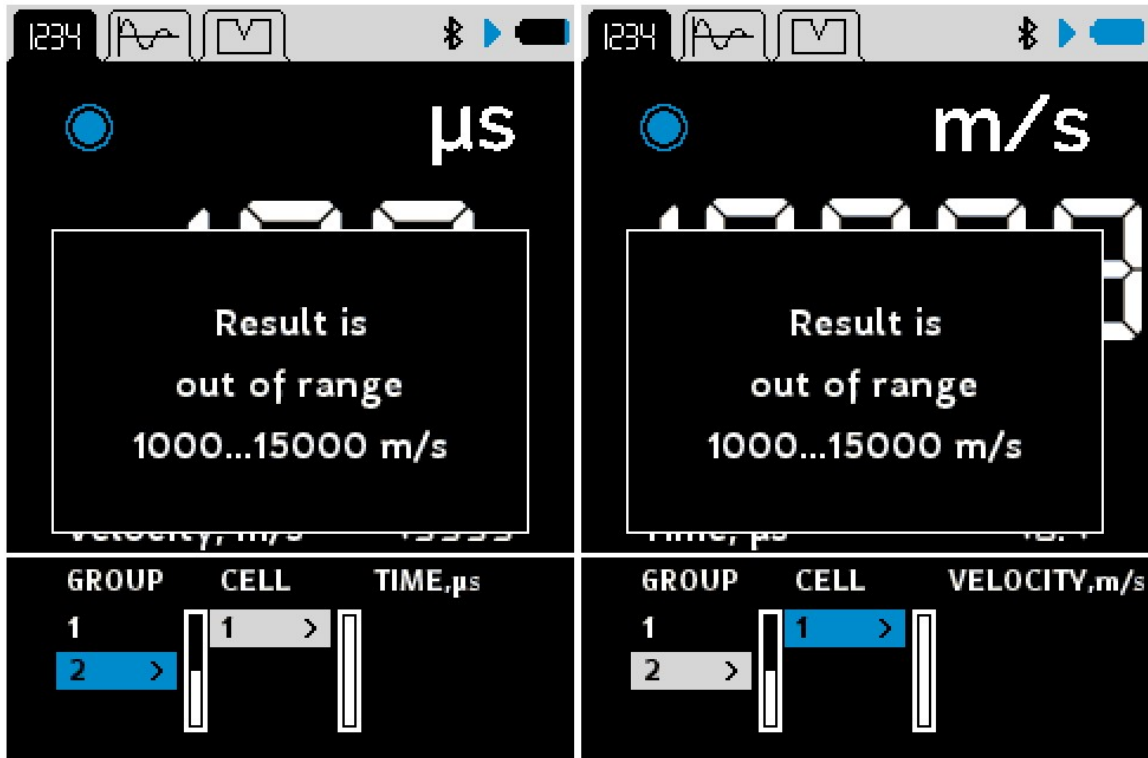

The A1410 PULSAR does not save an out-of-range result.

3.3 Waveform mode

The `waveform` mode shows both a numeric indicator and a waveform. The waveform helps an operator to estimate the signal quality and the correctness of time detection. The screen in the waveform mode has the following layout:

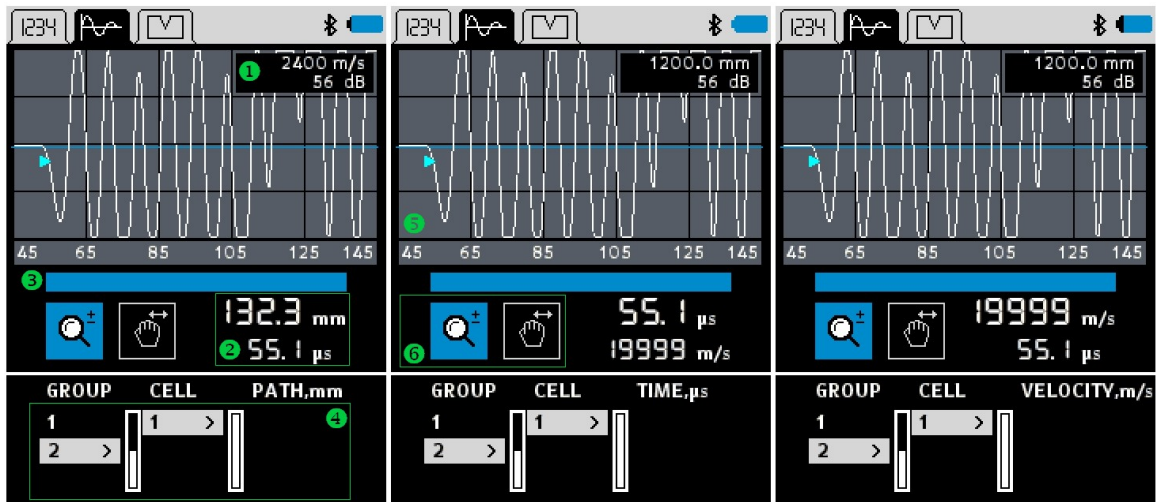

Figure 17: Waveform mode screens

Hint indicator

The indicator ① shows the current value of [gain](#)^[13]. The indicator also shows velocity (if result type = velocity/time) or base (if result type = path/time).

Unit's indicator

For the detailed description of the units's indicator ② refer to [page](#)^[23]

Progress bar

For detailed description of progress bar ③ refer to [page](#)^[23]

Group/cell control





For detailed description of the group/sell control ④ refer to [page](#)^[25]





Waveform plot

The waveform plot ⑤ shows received a-scans. Its axis introduces time in microseconds. The marker  indicates the arrival time

Waveform control

At the end of the measurement the operator may perform zooming in/out and shifting left/right of the waveform using waveform control ⑥. For zooming

in/out press and hold the key . The icon  became selected . Use the arrow buttons   (short pressing) for zooming in/out. For

shifting left/right press and hold the key . The icon  became selected . Use the   (short pressing) for shifting left/right.

3.4 Crack mode

The screen in the `crack` mode has the following layout:

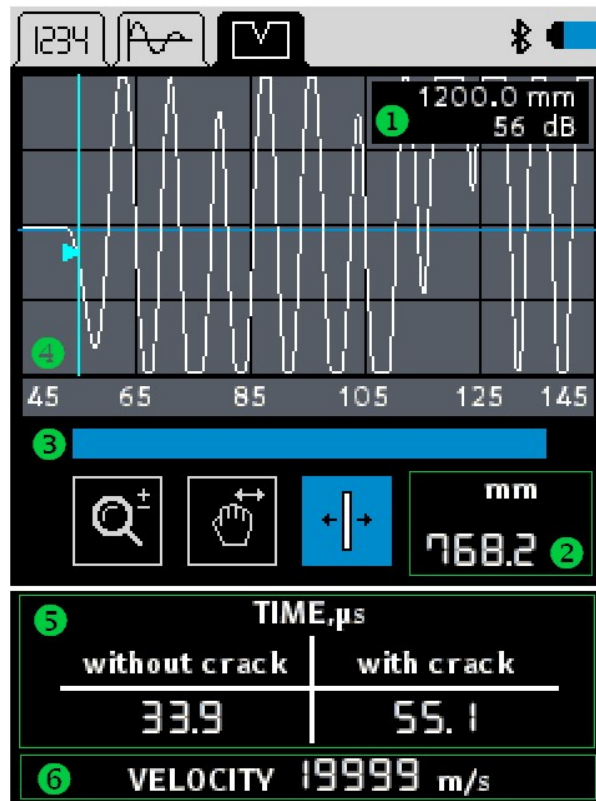

Hint indicator

For the detailed description of the hint indicator **1** refer to [page 28](#).

Crack depth indicator

The indicator **2** shows the estimated depth of the crack pitch.

Progress bar

For the detailed description of the progress bar **3** refer to [page 23](#).

Waveform plot

For a detailed description of the waveform **4** refer to [page 28](#).

Time indicator

The indicator **5** has two segments. The first segment (without crack) shows sound propagation time from the transmitter to the receiver. Figure 17(left) illustrates direct propagation time T_{direct} . The second segment (with crack) indicates the propagation time from the transmitter to the crack pitch and from the crack pitch to the receiver. Figure 17 (right) illustrates the total propagation time T_{total} .

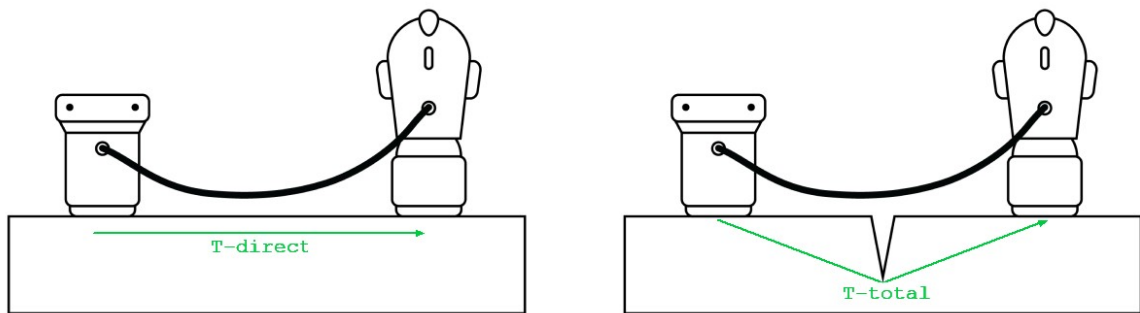



Figure 18: Direct and total sound propagation times

Velocity indicator

The indicator **6** shows sound velocity calculated out of base and the $T\text{-direct}$ time value.

Waveform control

For a detailed description of zoom  and shift  functions refer to the [page](#)²⁸.

Due to signal attenuation, acoustical disturbances, or geometrical influences, $T\text{-total}$ may jitter. To adjust $T\text{-total}$ the operator may use the time correction

function . Activate the time correction  by pressing and holding the  key, then use the   keys for fine tuning.

3.4.1 Crack detection

This chapter guides you through parametrization and the estimation of the crack depth.

Select sound path

Before starting the estimation, the path AB and the angle A must be settled, see Figure 18. The path may vary between 100 and 300 millimeters. The optimal angle lies between 5 and 35 degrees.

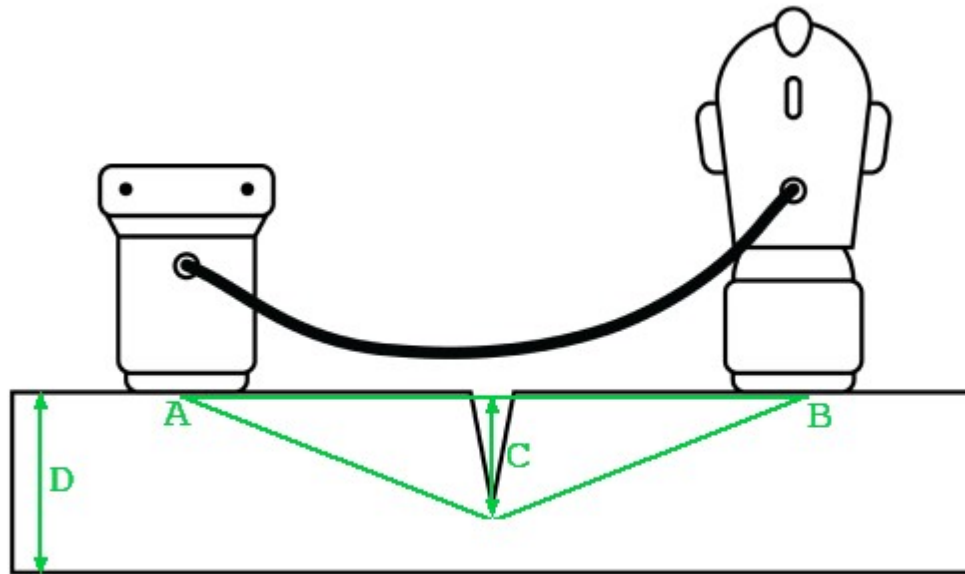

Figure 19: Crack detection parameters

To ease the choice of the path and the angle, use the following table whose cells are approximate crack depth C . If you are not sure about C value, use the real sample thickness D instead. The selected table cell will give you recommended A and AB values.

A, deg AB, mm	100	125	150	175	200	225	250	275	300
5	4	5	6	7	8	9	10	11	13
10	8	10	12	15	17	19	21	23	25
15	12	16	19	22	25	28	32	35	38
20	16	20	25	29	33	37	41	46	50
25	20	25	30	36	41	46	51	56	61
20	24	30	36	42	48	54	60	66	72
35	27	34	41	47	54	61	68	75	82

NOTE

In case if several options are available, for example $C = 12$ ($A = 15$, $AB = 100$) and $C = 12$ ($A = 10$, $AB = 150$), use the one where A is closer to the middle of its range, namely 5 - 35, deg. The correct choice, in this example, would be $C = 12$ ($A = 15$, $AB = 100$).

Starting the evaluation

- Set the parameter $base = AB$, which defines the path between the transmitter and the receiver.
- Keep AB unchanged during the whole measurement
- Switch on the crack mode. A1410 PULSAR shows the following screen. The propagation time $T_{-direct}$ = without crack, the total time T_{-total} = with crack, velocity and crack depth are unknown.

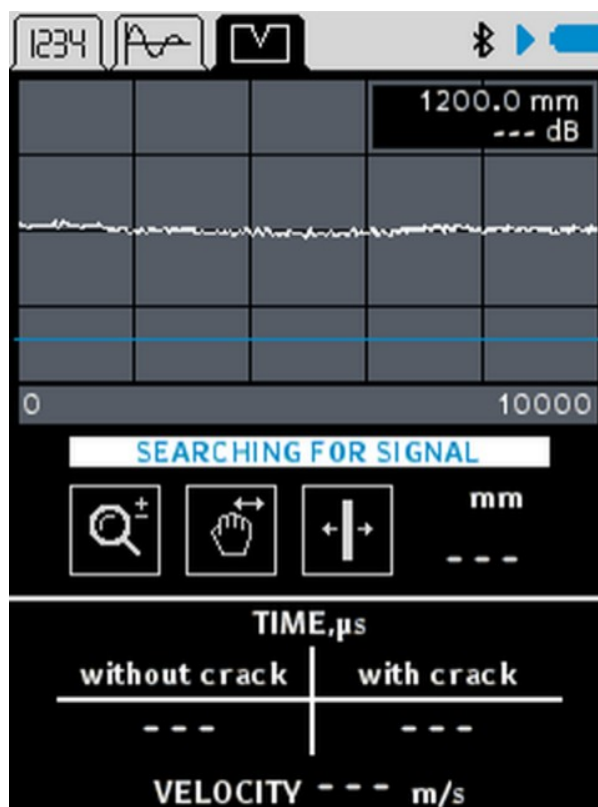



NOTE

During the measurements, keep the transmitter and the receiver orientation as shown in Figure 19. The transmitter is on the left-hand side. The LEMO connectors of both the transmitter and the receiver look in the same direction.

Estimation of $T_{-direct}$

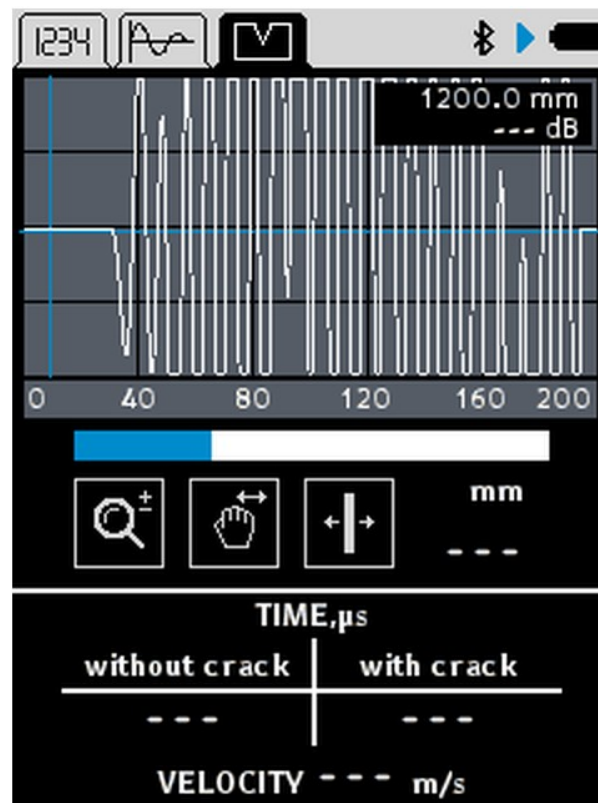
- Take a crack-free sample for $T_{-direct}$ estimation. During the measurement, the progress bar indicates the current state of the process.



- At the end of the measurement, the A1410 PULSAR highlights T_{direct} and velocity red. If the values are correct, confirm this measurement step using the enter button. A yes/no dialog appears. If the result is satisfying save it with the  key, the estimated values turn white. If the estimation is not satisfying, press the  key and repeat the measurement.

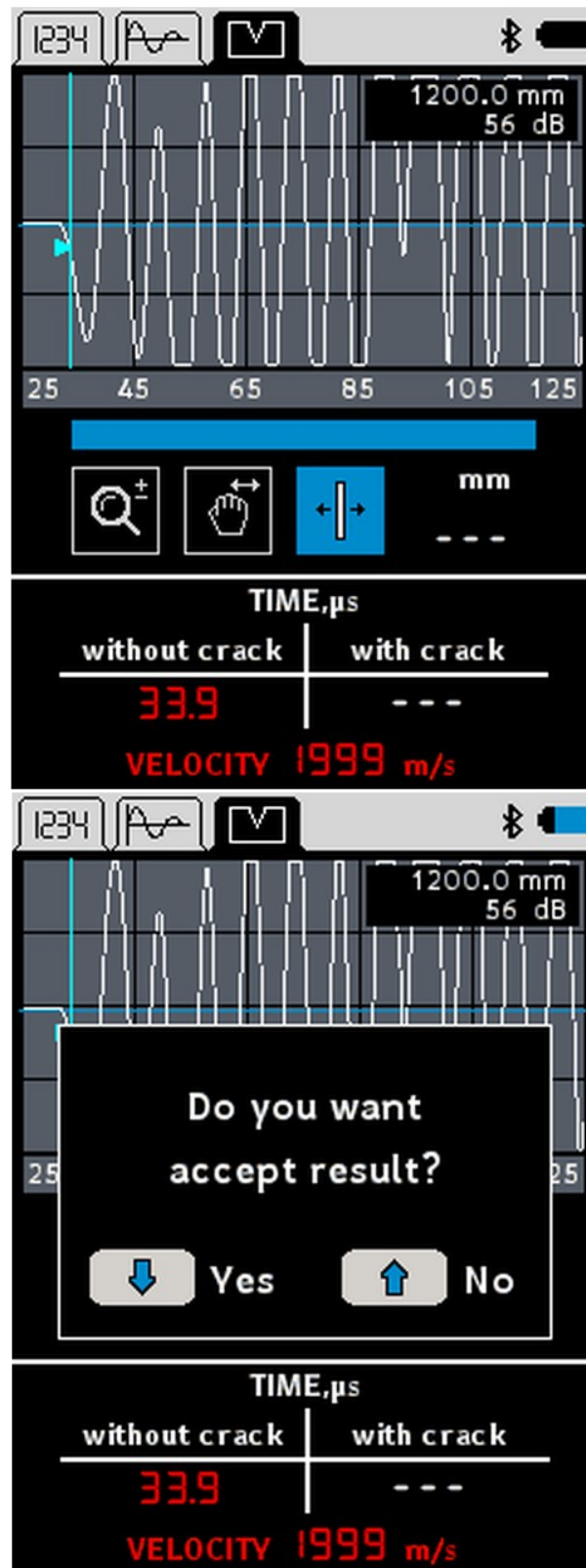

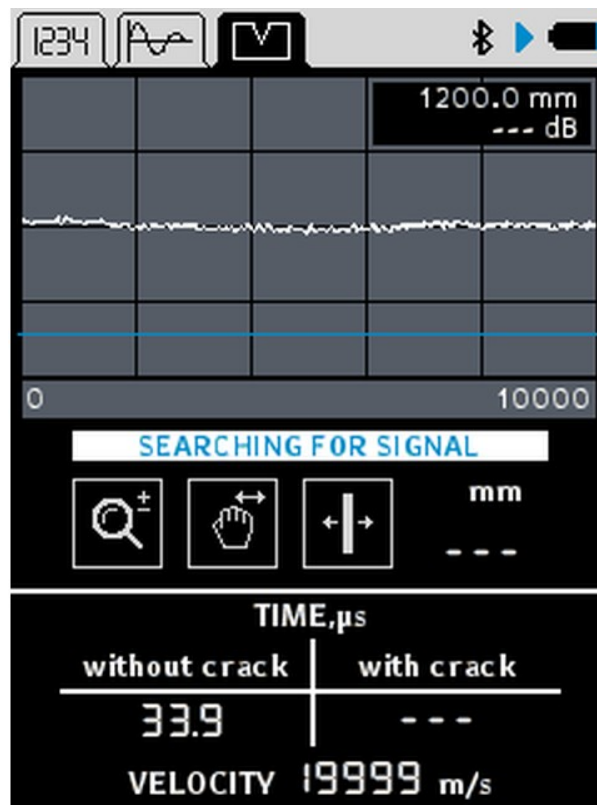



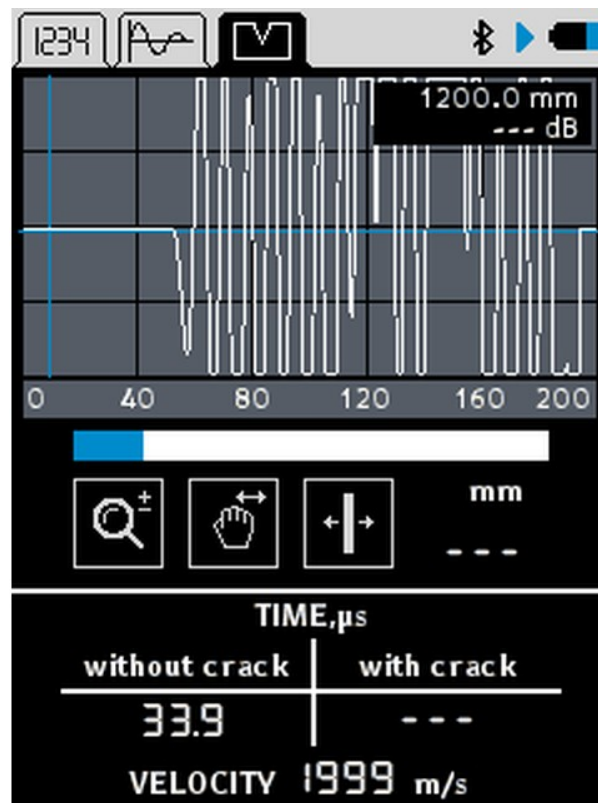

Estimation of T-total

- Repeat the procedure as it is given in the previous step on a sample with a crack. Follow up the steps for measuring and saving the result. The progress bar shows the scanning



NOTE

During the measurements, keep the transmitter and the receiver orientation as shown in Figure 19. The transmitter is on the left-hand side. The LEMO connectors of both transmitter and receiver look in the same direction.

- At the end of the measurement, the A1410 PULSAR highlights t_{total} and the crack depth white. If the values are correct, confirm this measurement step using the enter button. Follow up the yes/no dialog. Save the result with the  key. If the estimation is not satisfying, press the  key and repeat the measurement.
- After the result being saved the operator can zoom in/out  the waveform, shift  the waveform, or adjust the estimation using .

4 Applications

This chapter describes howto's

4.1 Signal quality

Time estimation errors

The A1410 PULSAR detects the arrival time of the transmitted pulse analyzing some waveform events. The first event is waveform's first change from zero to minus values, see ❶ on Figure 19, also called the inflection point. The second event is the waveform's rise from minus values to zero forming a peak ❷, also called first negative peak.

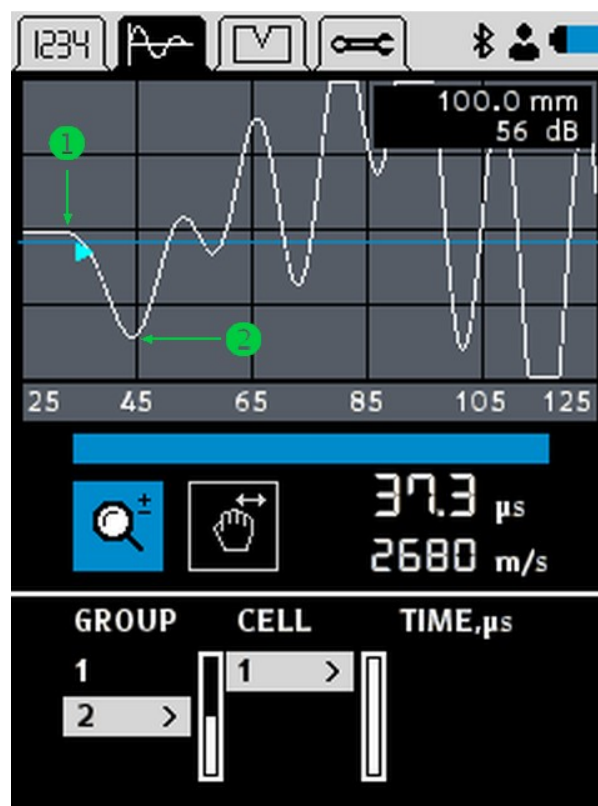

Figure 20: Waveform events

In some cases, these events may diminish due to some factors as: geometrical sample properties, wave attenuation, noise. The degradation leads to arrival time estimation errors. Use the waveform mode to check if the waveform has intense first and second waveform events.

NOTE

The minimal dimensions of the sample are 150 x 150 x 150 millimeters. If at least one sample dimension is less than recommended, check the feasibility of the

measurement procedure with reference samples. Read more about special cases given from [page](#)^[38].

Saturation

For example, in rare situations, the waveform amplitude may override the dynamic amplifier range. Refer to Figure 20 to see an example of the saturated signal **1**. The amplifier cuts the maximum of the peak. Try to avoid saturation by reducing the gain value; see [auto gain](#)^[13] and [gain](#)^[13] parameters.

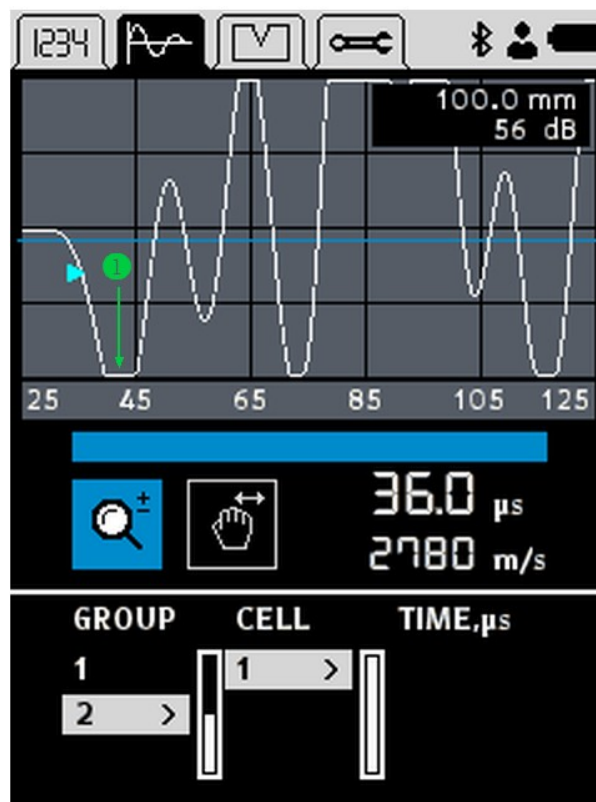

Figure 21: Saturation example

4.2 Core testing

Typical core diameter varies from 50 to 140 millimeters. The length is usually between 100 and 300 millimeters. Since the core diameter is less than recommended sample dimensions, the time estimation errors may occur. This chapter describes how to reduce possible errors.

Auto search depth

The A1410 PULSAR allows the operator to switch off `auto search depth`. This tells the algorithm to stop searching for the [waveform events](#)^[38] after the time given by the `search depth` in microseconds. If `auto search depth = off`, the A1410 PULSAR indicates the `search depth` time with a vertical line **1**, see Figure 21. Adjust a search depth time so that the first negative peak **2** lies before line **1** and there are no other peaks in that time interval.

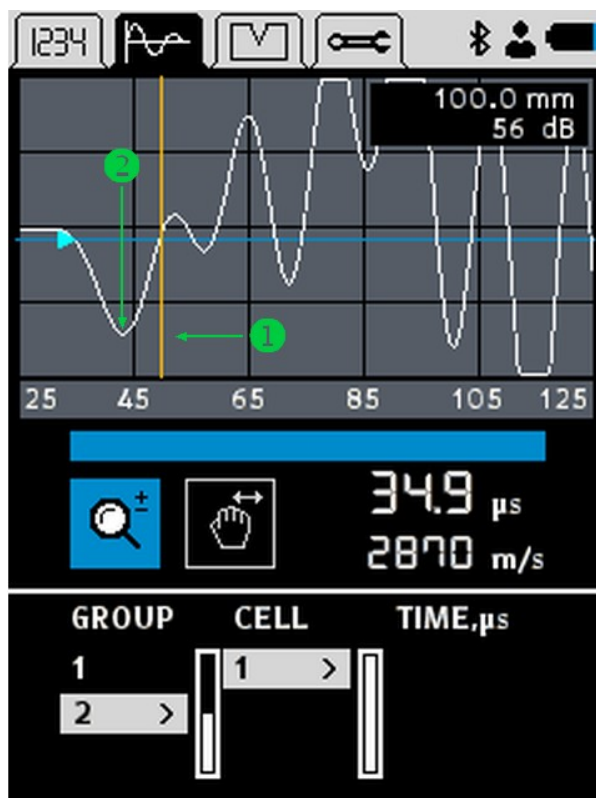

Figure 22: Search depth set correctly

Figure 22 shows an example of a false search depth setting. Here, before line ①, there are some peaks, namely from ① to ⑤.

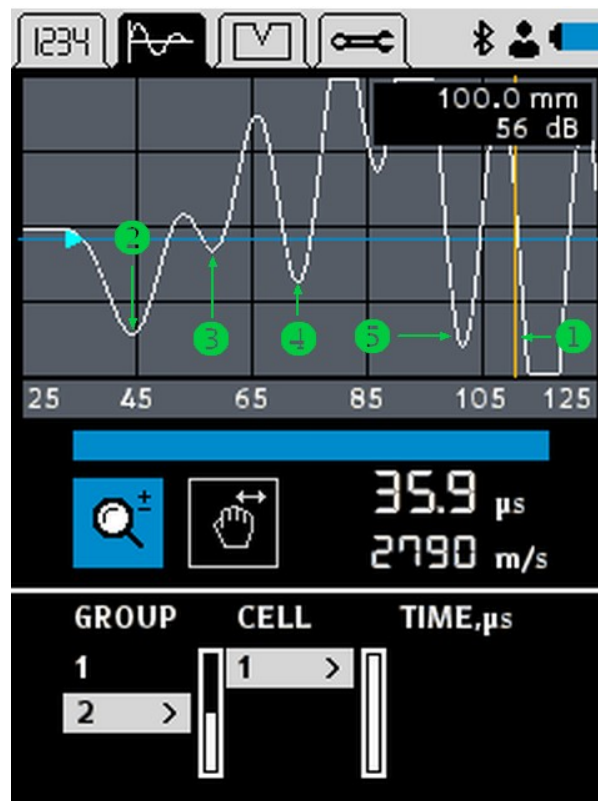

Figure 23: Search depth set wrong

Transmitter-receiver arrangement

In case of the thin sample the multiple reflections from the walls arrive at the receiver almost simultaneously, Figure 23. The superposition of the waves traveling along paths ① and ② (and other paths which are not depicted) diminishes the [waveform events](#).^[38] This results in significant time estimation errors.

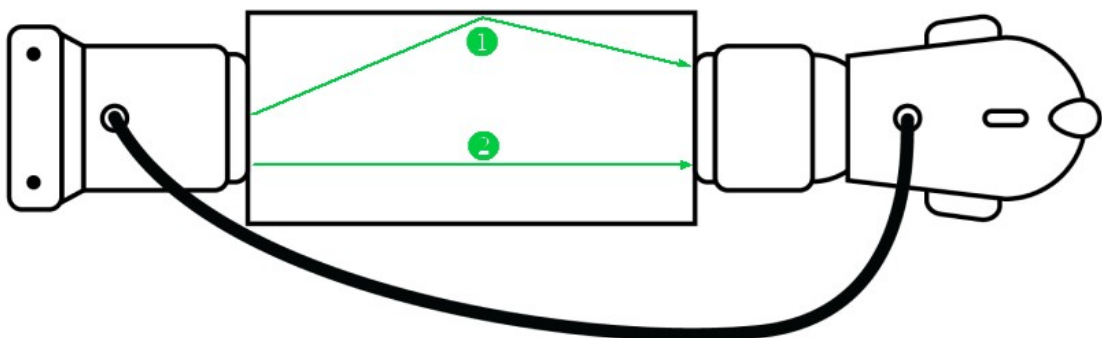

Figure 24: Standard arrangement

Try to reduce the influence of the multiple reflections by using the following transmitter-receiver arrangement, see Figure 24:

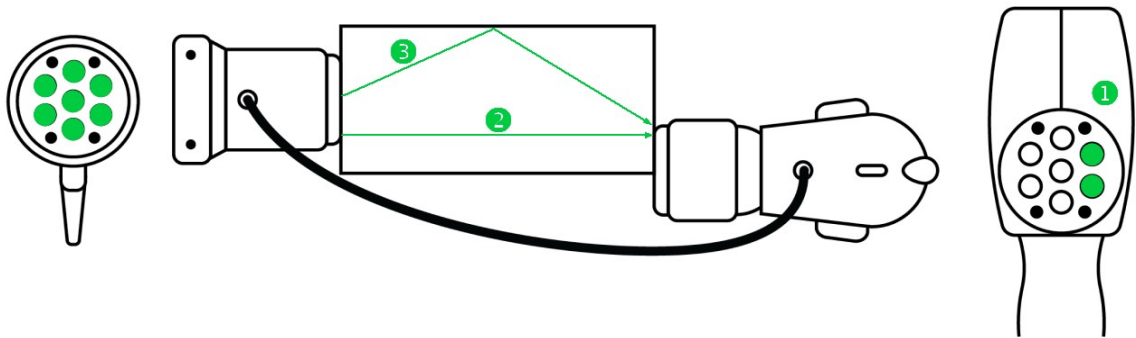

Figure 25: Core testing arrangement, Tx = 2, Rx = 7.

The receiver touches a sample only by two sensors (active sensors) labeled as ①. The transmitter uses all sensors. Thus, the sound path ② became shorter than the path ③. The [waveform events](#)^[38] experience minor damages.

If the signal still became [saturated](#)^[38] and unstable, reduce the number of the transmitter's active sensors, see Figure 25 ① and ②.

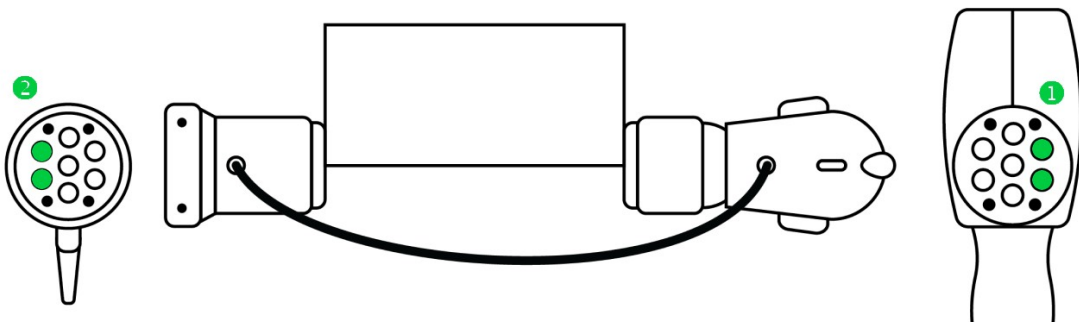

Figure 26: Core testing arrangement, Tx = 2, Rx = 2



WARNING

Do not change the arrangement during series of measurements. Check the instrument on some core reference sample regularly.